

**FAMSI © 2005: Andrew K. Scherer**

## **Archaeological Reconnaissance at Tixan: Explorations in the Southern Sierra del Lacandón National Park, Petén, Guatemala**



**Research Year:** 2005

**Culture:** Maya

**Chronology:** Classic

**Location:** Petén, Guatemala

**Site:** Tixan, Sierra del Lacandón National Park, Unión Maya Itza, Oso Negro, Cueva de Tres Entradas, La Pasadita, El Túnel, La Técnica, El Kinel

### **Table of Contents**

[Abstract](#)

[Resumen](#)

[Introduction](#)

[Methodology](#)

[Unión Maya Itza](#)

[Oso Negro](#)

[Cueva de Tres Entradas](#)

[La Pasadita](#)

[El Túnel](#)

[Tixan](#)

[La Técnica](#)

[El Kinel](#)

[Discussion and Conclusions](#)

[The Future of the Sierra del Lacandón National Park](#)  
[Personnel of the 2005 Sierra del Lacandón Regional Archaeology Field Team](#)  
[Acknowledgements](#)  
[List of Figures](#)  
[Sources Cited](#)

## **Abstract**

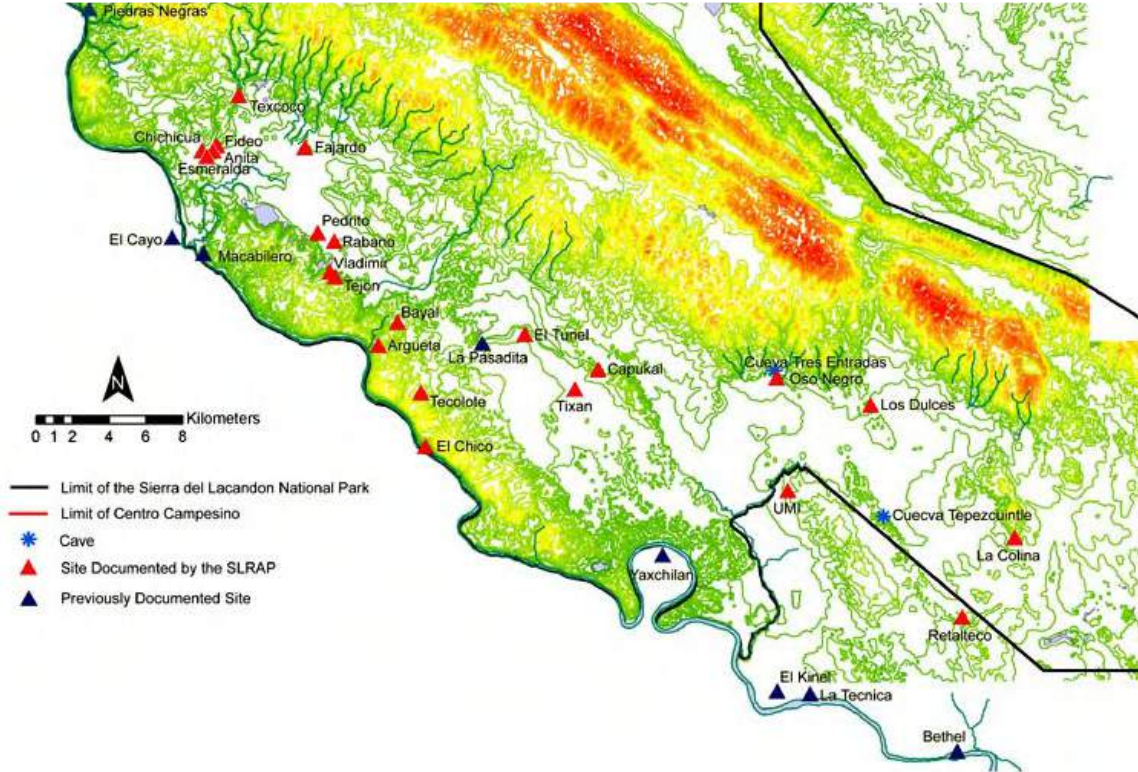
This report describes the results of three weeks of reconnaissance in the southern portions of the Sierra del Lacandón National Park, Petén, Guatemala. This area is the source of numerous looted monuments that can be attributed to the Classic Maya kingdom of Yaxchilán. These looted monuments include a lintel that was intercepted in 2004 by Guatemalan authorities in the modern community of Retalteco, located near the southern end of the park. Prompted by the recovery of this monument, members of the Sierra del Lacandón Regional Archaeology Project (SLRAP) attempted to visit an area of the park known as Tixan, which is reported to contain vaulted structures and is a possible source of this monument. Three weeks of reconnaissance in the southern portion of the Sierra del Lacandón National Park has provided a more complete understanding of settlement within the Yaxchilán kingdom.

## **Resumen**

El presente informe describe los resultados de tres semanas de reconocimiento en la parte sur del Parque Nacional Sierra del Lacandón, Petén, Guatemala. Esta área es la fuente de numerosos monumentos saqueados, que pueden ser atribuidos al reino Clásico maya de Yaxchilán. Estos monumentos saqueados incluyen un dintel que fue interceptado en el 2004 por las autoridades guatemaltecas en la moderna comunidad de Retalteco, localizada en el extremo sur del parque. Tan pronto como se recuperó dicho monumento, miembros del Proyecto Regional Arqueológico Sierra del Lacandón (PRASL), intentaron visitar el área del parque conocida como Tixan, en la cual se han reportado estructuras abovedadas y que posiblemente sea el origen de ese monumento. Como resultado de tres semanas de reconocimiento en la parte sur del Parque Nacional Sierra del Lacandón, actualmente se tiene una mejor comprensión del asentamiento del reino de Yaxchilán.

*Submitted 08/31/2005 by:*

Andrew K. Scherer  
Department of Anthropology and Sociology  
Wagner College  
[ascherer@wagner.edu](mailto:ascherer@wagner.edu)



**Figure 1. Archaeological Map of the Sierra del Lacandón after three years of reconnaissance by the Sierra del Lacandón Regional Archaeology Project.**

## Introduction

The Sierra del Lacandón Regional Archaeology Project (SLRAP) began work in 2003, with support from FAMSI (grant [#02020](#)), exploring the Classic Maya political geography of the Sierra del Lacandón National Park, Petén, Guatemala (the park is referred to hereafter by its Spanish acronym, PNSL). The focus of this research is to investigate the dynamics of borders, boundaries, and frontiers within and between the Classic Maya kingdoms of Piedras Negras and Yaxchilán ([Golden 2003b](#)). Following two years of research by the SLRAP in 2003 and 2004, the archaeological map of the Sierra del Lacandón is much more complete ([Figure 1](#)). In addition to the identification and documentation of numerous rural centers, this research has also resulted in the preliminary documentation of Texcoco, a secondary center in the Piedras Negras kingdom, and the identification of Tecolote, a secondary center in the Yaxchilán kingdom (Golden, Romero, *et al.* 2005; Golden, Scherer, *et al.* 2005; Golden, *et al.* 2003). Current archaeological and epigraphic evidence indicates that Tecolote and La Pasadita, another of Yaxchilán's secondary centers, formed part of the northern border of the Yaxchilán polity during the Late Classic period (Golden 2003a; Golden, Scherer, *et al.* 2005). However, prior to reconnaissance in the 2005 field season, little was known about settlement between Yaxchilán's northern border and the polity capital itself.

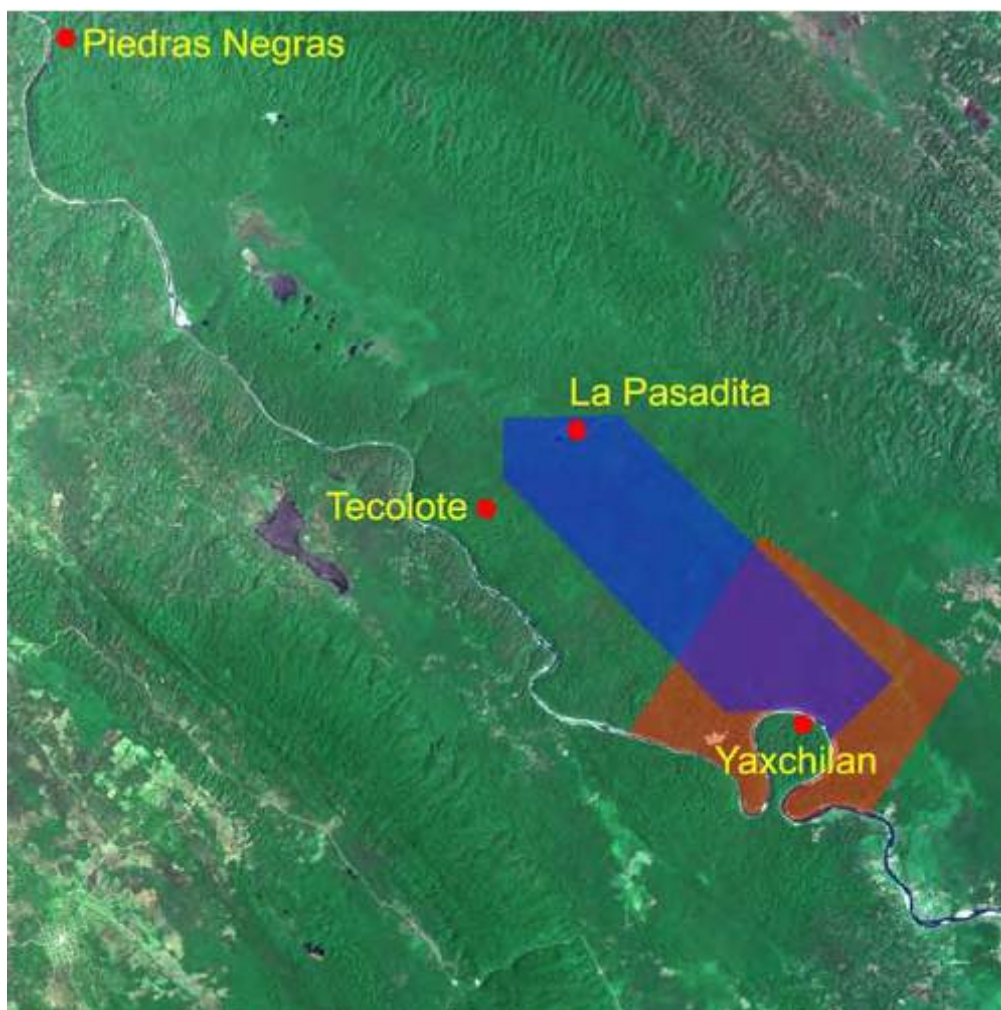
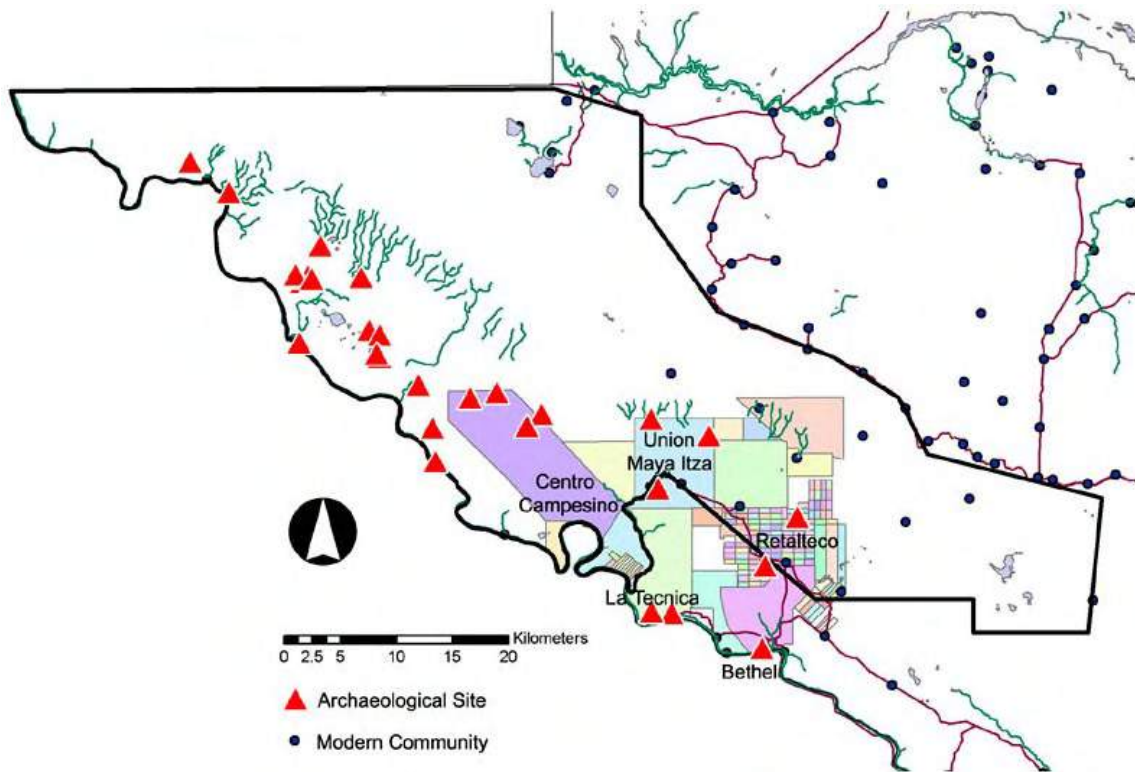


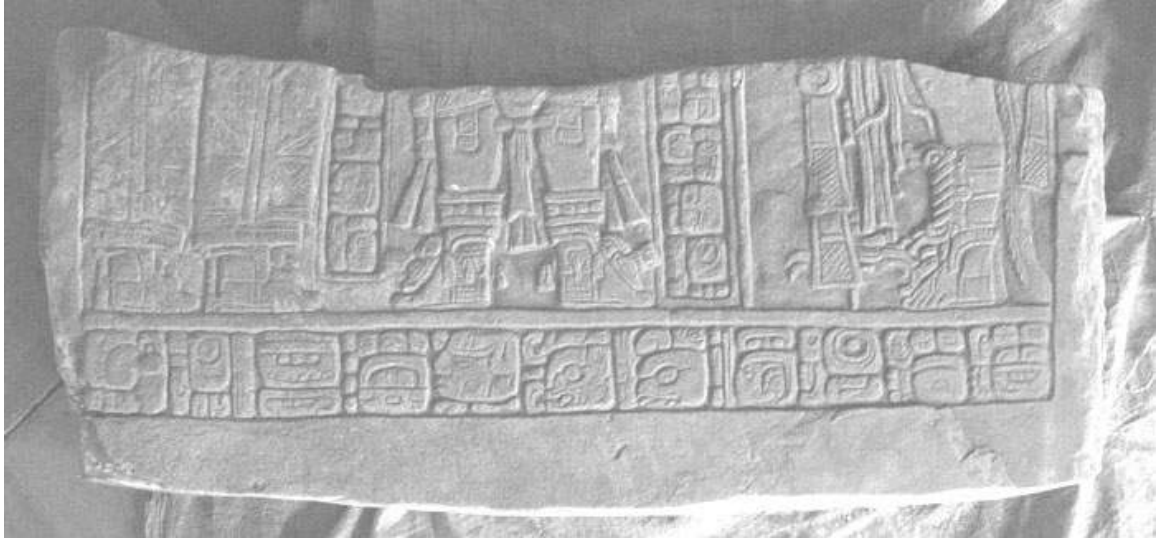
Figure 2. Proposed location of the archaeological site of Tixan (red) and location of the invaders from Centro Campesino (blue).

The SLRAP regularly employs guides who were once part of the Comunidades de Población en Resistencia de Petén (CPR-P), communities that took refuge in the Sierra del Lacandón during the civil war of the 1980s and 1990s. These guides lived for nearly two decades in the forest of the PNSL, and have a comprehensive understanding of the geography of the park and know of numerous undocumented archaeological sites. During the 2004 season, these guides reported the presence of a large archaeological site known to them as Tixan (previously reported as Tixchan) on the Guatemalan side of the Usumacinta river in the vicinity of Yaxchilán ([Figure 2](#), shown above). According to their reports, Tixan includes a number of vaulted and formerly vaulted structures. Thus, it is quite likely that Tixan is the source of some of the looted monuments that can be attributed to the region, but cannot, as yet, be linked to any known archaeological site. Unfortunately, Tixan is also in the vicinity of an illegal invader community known as Centro Campesino.

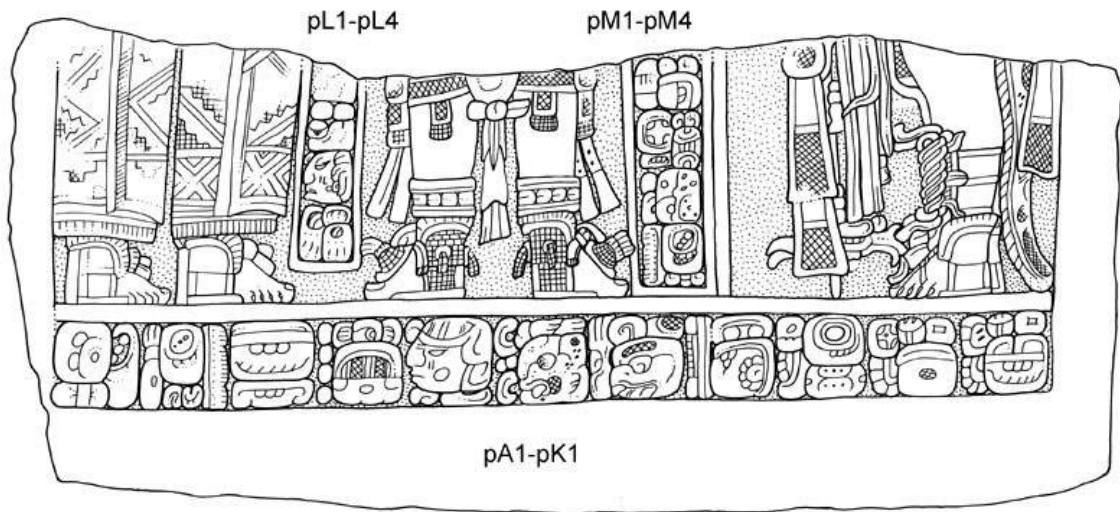


**Figure 3. Map of modern communities in the vicinity of the Sierra del Lacandón National Park, Petén, Guatemala. The borders of the park are shown by the solid black line.**

The need to visit Tixan was heightened in July of 2004 when Guatemalan authorities intercepted a looted monument fragment in the modern community of Retalteco, located on the southern end of the Sierra del Lacandón National Park ([Figure 3](#)). Charles Golden and René Muñoz of the SLRAP were permitted to photograph the monument ([Figure 4a](#)) and a drawing and interpretation of the monument has recently been completed by Stephen Houston ([Figure 4b](#)). A summary of Houston's interpretations are as follows: The monument features Bird Jaguar IV of Yaxchilán accompanied by three other individuals. To his right are two of his spouses, Ix Mut B'alam of Hix Witz and a second spouse who is not named in the preserved portion of the text. On Bird Jaguar's left is his *b'ajaj sajal* (principal noble), K'an Tok Wayib'. K'an Tok Wayib' was apparently an important figure, making an appearance on at least three other Yaxchilán monuments (Martin and Grube 2000: 130). Although the date of the monument is missing, it names Bird Jaguar IV as a four *k'atun ajaw*. This implies a date between A.D. 768 (the year he would have become a four *k'atun ajaw*) and A.D. 771 (the year Shield Jaguar III came to power).



**Figure 4a. Looted monument fragment recovered in the community of Retalteco, Petén, Guatemala (photograph by Charles Golden).**



**Figure 4b. Looted monument fragment recovered in the community of Retalteco, Petén, Guatemala (drawing by Stephen Houston).**

It is almost certain that the monument recovered in Retalteco, like many of the looted monuments from the region, was part of a lintel from a vaulted structure. Initial reports from Guatemalan authorities indicated that the individuals from whom the monument was recovered identified Centro Campesino as the original find site for the sculpture. As members of the SLRAP had recently received reports about the existence of Tixan, the presence of vaulted architecture at the site, and since these reports placed Tixan within the boundaries of Centro Campesino, Tixan seemed the most probable site of origin for the monument.

With this information in mind, a component of the SLRAP set out in May 2005 to conduct reconnaissance in the southern end of the Sierra del Lacandón to confirm the location of the archaeological site reported as Tixan and determine whether Tixan was the source of the Retalteco monument or any of the other looted monuments that have been extracted from the Sierra del Lacandón. This research team consisted of both American and Guatemalan archaeologists, assisted by guides from the former CPR-P communities and workers from Dolores, Petén. Our plan was to establish a base of operations at the Consejo Nacional de Áreas Protegidas (CONAP) station at Ceiba de Oro, which is on the Guatemalan side of the Usumacinta River near Yaxchilán.

However, days before the project was to begin, the SLRAP was informed by the Defensores de la Naturaleza, who co-administer the national park with CONAP, that it was no longer safe to work out of the Ceiba de Oro station. Earlier in 2005, Ceiba de Oro was vandalized by residents of Centro Campesino and some of the station's equipment had been stolen. Thus, it was not possible to guarantee the safety of SLRAP staff working in and around Ceiba de Oro. Rather than canceling the field season, the Defensores recommended that the SLRAP contact the leaders of Unión Maya Itza (UMI), a legal logging community on the southern end of the national park, and request permission to use UMI as a base of operations. Since the parcel of land belonging to UMI is located directly east of Centro Campesino it was thought that some portions of Tixan may lie within UMI and could be safely reached ([Figure 3](#)). Fortunately, the UMI community leaders kindly permitted the SLRAP to live within the community and conduct archaeological reconnaissance in the area.

After three successful weeks of reconnaissance, we now have a more complete understanding of settlement within the Yaxchilán kingdom. This report describes the identification of these new sites, including Unión Maya Itza, Oso Negro, and the northern portions of Tixan. In addition, we were able to conduct additional studies of two previously documented sites: La Pasadita, El Túnel and La Técnica/El Kinel. Finally, we explored several caves in the region, including the Cueva de Tres Entradas.

## **Methodology**

Following the general survey methodology of the SLRAP, reconnaissance was conducted with the assistance of guides who are former residents of the refugee CPR-P communities and are intimately familiar with the terrain of the Sierra del Lacandón National Park. Rather than conducting straight-line transects, reconnaissance generally involved opportunistic travel to undocumented sites known to the guides, and additional settlement was often identified and recorded during these trips. GPS coordinates, field notes, and photographs were taken for all significant cultural and natural features. A sample of the settlement from each site was mapped using a handheld Leica Disto EDM and compass. When possible, ceramic samples were recovered from the surface and in looter's trenches in order to date the settlement. No excavation was undertaken.

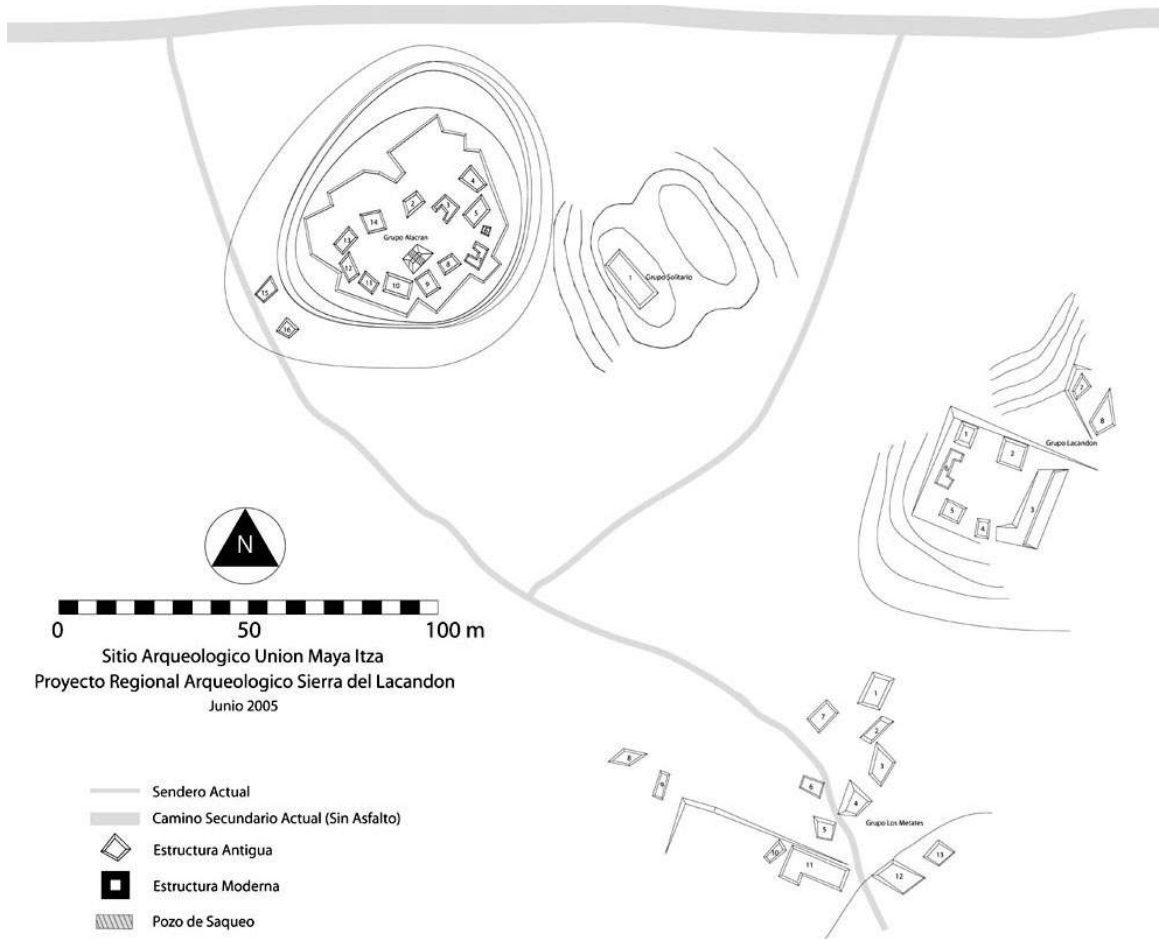


Figure 5. Modern community of Unión Maya Itza, Petén, Guatemala.

### Unión Maya Itza

The archaeological site of Unión Maya Itza (UMI) consists of a number of mound groups densely scattered within and around the modern community of the same name ([Figure 5](#), shown above). At the present time, all of these mound groups are being treated as the same site, though a more thorough survey may indicate the presence of distinct settlement clusters. A sample of this settlement was mapped and includes the groups Los Metates, Lacandón, Solitario, and Alacran ([Figure 6](#)). Architecture at UMI is modest, consisting of house mounds 1-2 meters high. Interestingly, formal, rectangular patio groups are scarce at UMI, with most mound groups consisting of densely clustered mounds (i.e., Alacran Group and Los Metates Group). This is quite unlike much of the Classic period settlement in the Sierra del Lacandón where formally arranged rectangular patio groups are the norm. Ceramics recovered on the surface of UMI date to the Late and Terminal Classic period ([Figure 7](#)), and these distinctive settlement patterns at UMI may simply be another form of Classic period settlement not previously encountered in the area.





**Figure 6. Map of the archaeological site of Unión Maya Itza, Petén, Guatemala.**



**Figure 7. Profiles of ceramic sherds recovered on the surface of Unión Maya Itza (drawing by Ana Lucía Arroyave).**

The only group identified to date that might constitute a ritual center at UMI is the Alacran Group. This group consists of a leveled hilltop with fourteen mounds. One of these mounds, Mound 1, is a small, two meter high pyramidal shaped structure that was bisected by a looter's trench ([Figure 8](#)), though it does not appear that the looters encountered anything of importance.



**Figure 8. Mound 1, Alacran Group, Unión Maya Itza. The archaeologist in the foreground is inside of a looter's trench.**

The lack of a major ceremonial center suggests that UMI was directly subordinate to Yaxchilán (approximately 7.6 km to the southeast), or perhaps a secondary center in the area such as Oso Negro (approximately 6.2 km to the north). Based on the density of mound groups, it is clear that population levels in the area of UMI were quite high. Immediately adjacent to the archaeological settlement are large areas of flat, low-lying terrain that likely served as agricultural fields during the Classic period. In fact, much of this same area is used for *milpa* by the modern community at UMI ([Figure 9](#)), and it seems a likely hypothesis that UMI was one of many agricultural communities under the control of the Yaxchilán polities that supplied food and other resources to the capital and subordinate political centers in the kingdom.



**Figure 9.** Agricultural field north of the modern community of Unión Maya Itza. The archaeologist on the left is standing atop an archaeological mound.



**Figure 10a.** Lacandón incensario recovered on the surface of Unión Maya Itza. Vessels matching the style of Figure 10a are often referred to as "god pots."

While mapping the Lacandón Group of UMI, members of the SLRAP recovered two Lacandón ceramic vessels placed on the surface of one of the mounds ([Figure 10a](#), shown above, and [Figure 10b](#), shown below). Inside both vessels were the remains of burned copal resin. Based on their style, these vessels are from the Historic period and date to the late nineteenth or early twentieth centuries (Joel Palka, personal communication, 2005). In particular, the "god pot" ([Figure 10a](#)) is strikingly similar to other historic period Lacandón vessels that feature nearly identical anthropomorphic designs (Maler 1903: Plate LXXX; Palka 2005: figure 10.3). Like similar vessels that were recovered in structures or on the surface at Piedras Negras and Yaxchilán, the UMI vessels were placed by Lacandón Maya as they visited archaeological sites throughout the area during Historic times.



Figure 10b. Lacandón incensario recovered on the surface of Unión Maya Itza.

## Oso Negro

While conducting reconnaissance at UMI, local inhabitants reported the existence of a major archaeological site located to the north of the community in an area known locally as Oso Negro. The site name is in reference to a black anteater (*oso hormiguero negro* in Spanish) that was seen in a cave near the epicenter of the site. With the assistance of a local guide, members of the SLRAP were led to Oso Negro on the first day of field work, and conducted initial reconnaissance and mapping of Oso Negro over a period of five days.

The center of Oso Negro is dominated by a palace structure known as Las Puertas (Figure 11). Due to a lack of time in our brief field season, members of SLRAP were able to map only the site core of Oso Negro and conduct minimal investigations of its architecture. Thus, the plan in Figure 11 must be treated as preliminary until further reconnaissance, mapping, and excavation of Las Puertas is possible. Las Puertas is a five room, double-galleried palace situated atop a modified hill. One gallery of rooms faces west, while the other faces east. The east and west galleries were separated by a wall that appears to have lacked doorways. The palace itself was once vaulted, though the vault has since collapsed. However, the external doorway of the southeast entrance is still intact (Figure 12, shown below).

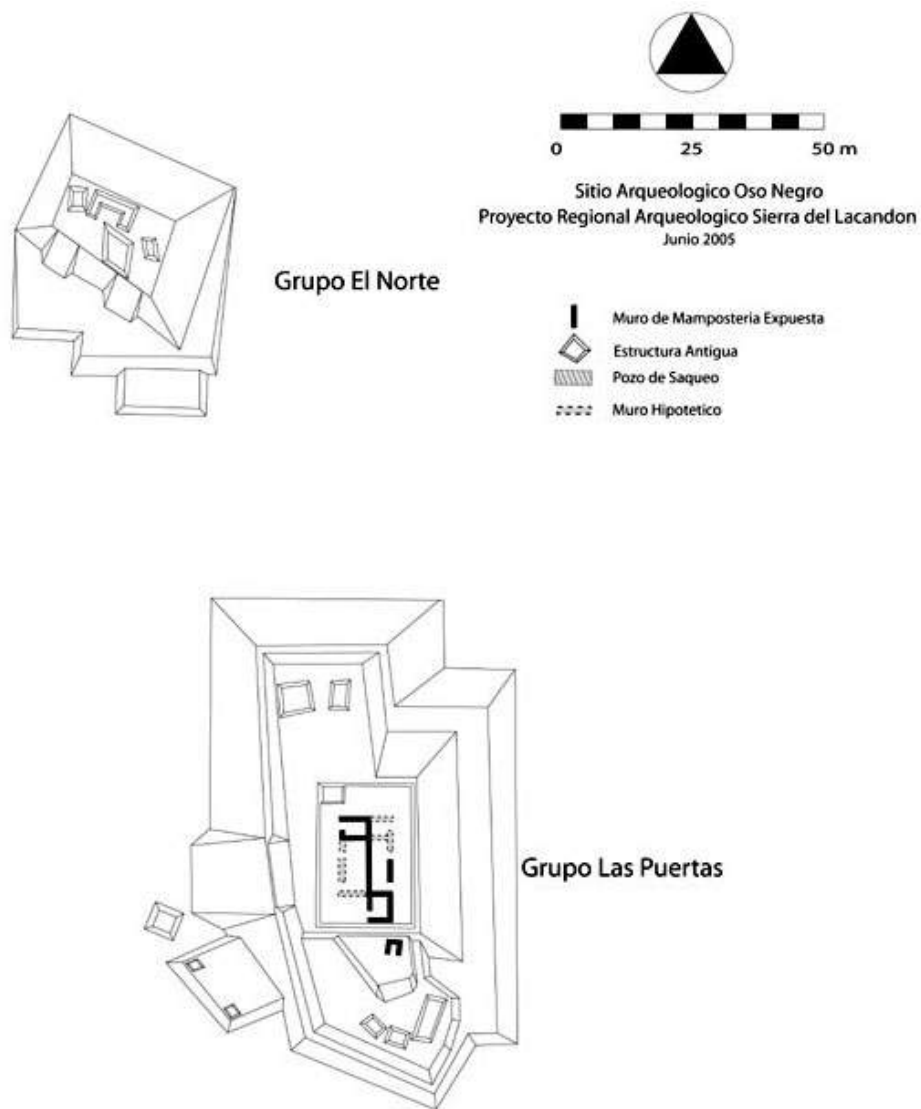


Figure 11. Map of Oso Negro, Petén, Guatemala.



**Figure 12. Southeast doorway of the Las Puertas Palace, Oso Negro. Note the doorway is filled with debris, giving the appearance that it was not constructed to full height.**

Southeast doorway of the Las Puertas Palace, Oso Negro. Note the doorway is filled with debris, giving the appearance that it was not constructed to full height. Although looting in the palace is extensive, it appears to be the work of amateurs, as the majority of the trenches are through the collapsed roof with very little of it penetrating beneath the original floor of the structure. Within the looter's trenches, it is possible to see some of the original walls of the structure. Thus, although the roof is destroyed, the structural walls appear to be largely intact. Wall niches were observed in both the southeast and northwest rooms. The axis of the structure is 0° magnetic north.



**Figure 13. Painted red lines on the lintel above the southeast doorway of the Las Puertas Palace, Oso Negro.**

While documenting Las Puertas, red lines were noted on the lintel of the one intact doorway ([Figure 13](#), shown above). These lines correspond to the width of the door and were likely used by the builders to either determine the width of the lintel needed to span the doorway or to assist in centering the lintel during construction.

The palace itself is located atop a large, modified natural hill consisting of at least five different levels. On the top level, the vaulted palace structure shares a platform with another smaller mound. To the north, two small mounds are located atop a lower platform. To the south of the structure, at least one walled structure sits atop a lower platform. A second, lower platform is located further to the south, featuring another three mounds. The southern platforms appear to have been accessed by a series of small stairways not shown in the plan of the site.





Figure 14. Profile of the staircase on the eastern façade of the Las Puertas platform, Oso Negro.

Although only one stairway is shown on the map, it is likely that stairways fronted both the east and west façades of the Las Puertas platform. The western stairway is still visible in profile, though it is eroding down the face of the platform (Figure 14, shown above). A low platform extends off the base of the western face of the complex. Another small mound is located in front of the western staircase. Although not shown in the drawing, preliminary observations of vault stones protruding from the rubble along the eastern slope of the hill suggest that a series of small vaulted structures were located on the lower platform of the eastern face of the complex. Such multi-level, acropolis-like arrangements of vaulted structures are found at other sites in the region, such as Bonampak and Tecolote. Overall, collapse and erosion of the Las Puertas group has been hastened by recent burning of the forest at Oso Negro by invaders from Centro Campesino.

Beyond the Las Puertas group, settlement at Oso Negro is relatively sparse. There is a second large platform to the north of the main group, though it lacks vaulted architecture. Beyond the site core, the majority of settlement consists of modest residential mound groups located along a series of *arroyos* (now dry) that drain from the Sierra del Lacandón from the northeast. This settlement consists of patio groups of three to five low mounds (1-2 meters high), usually situated atop a platform.



**Figure 15. Profiles of ceramic sherds recovered on the surface of Oso Negro (drawing by Ana Lucía Arroyave).**

No excavations were conducted at Oso Negro, so it is difficult to precisely date the site. However, ceramic sherds were recovered from the surface and in the looter's trench of Las Puertas ([Figure 15](#)). All of these sherds date from the Late to Terminal Classic periods, indicating that occupation at Oso Negro was probably contemporaneous with that of UMI nearby. Oso Negro is apparently like La Pasadita and Tecolote in that it was only occupied during the latter part of the Classic period. Also similar to La Pasadita and Tecolote, the ceramics of Oso Negro are unlike anything encountered at Piedras Negras (Muñoz 1999, 2000, [2004a](#)) and are more similar to what is known of the ceramics of Yaxchilán (Lopez-Varela 1989, 1992, 1994, 1995). However, Oso Negro is distinct from La Pasadita and Tecolote in that the surrounding settlement appears to be quite sparse. This may indicate that Oso Negro was only settled for a short time before it was abandoned, or may simply reflect a gap in our limited survey.

The Las Puertas palace also bears a striking similarity to the monumental architecture of Tecolote and La Pasadita (see [Golden 2003b](#)). These similarities include the use of monumental door lintels, the shape of building cornices, and the overall masonry style that incorporates a mix of fine-*lajas* with larger stones. Although no monuments have yet been found at Oso Negro, the architectural and ceramic parallels between Oso Negro, Tecolote, La Pasadita, and Yaxchilán itself strongly suggest that Oso Negro was part of the Yaxchilán kingdom. As a system of sites, Oso Negro, La Pasadita, and Tecolote (and presumably other as of yet unidentified centers) formed part of Yaxchilán's defensive, Late Classic northern border.

In fact, if we consider the location of Oso Negro, Tecolote, and La Pasadita in relation to one another and to Yaxchilán, it is possible to predict the location of other secondary sites. First, the mean distance from Yaxchilán to Oso Negro, Tecolote, and La Pasadita is 14 km. Second, Tecolote is approximately 5 km from La Pasadita, and Oso Negro is approximately 15 km from La Pasadita. Third, these secondary sites are all built on hill-slopes. Thus, it is reasonable to expect two more secondary centers to be located on hill-slopes somewhere in the 15 km stretch between La Pasadita and Oso Negro, approximately 14 km from Yaxchilán and roughly 5 km apart from one another ([Figure 16](#)). The SLRAP plans to test this hypothesis in future field seasons.

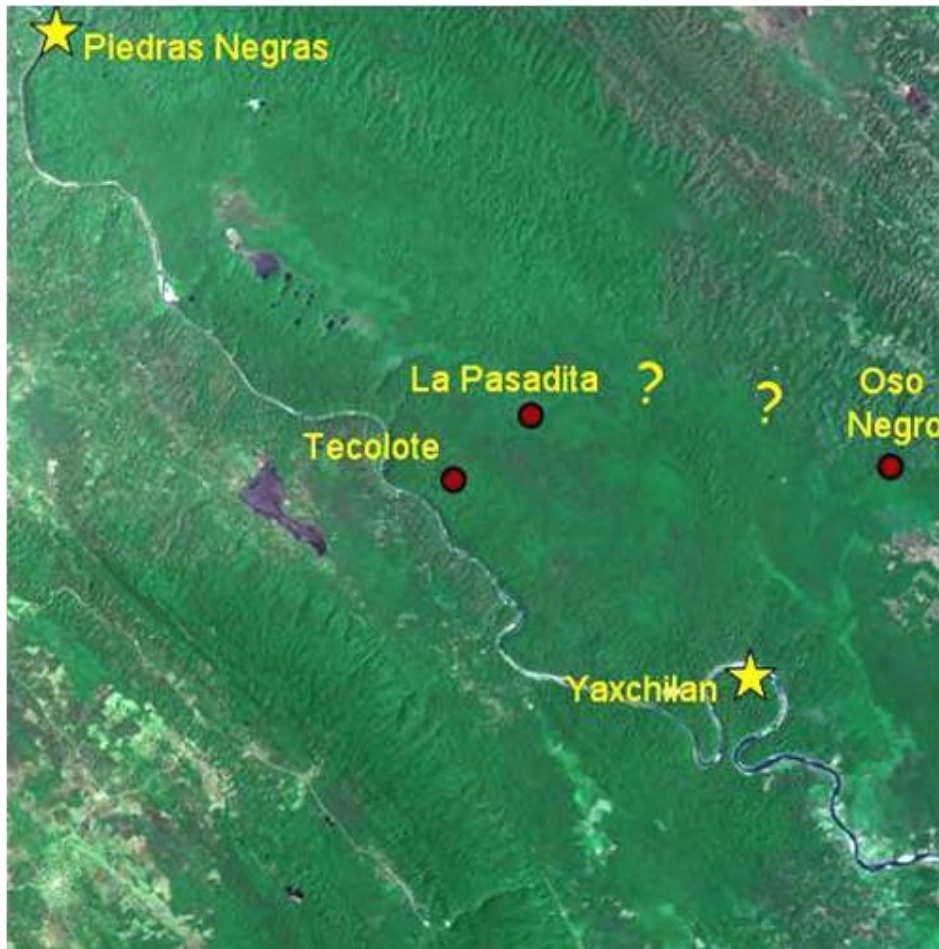
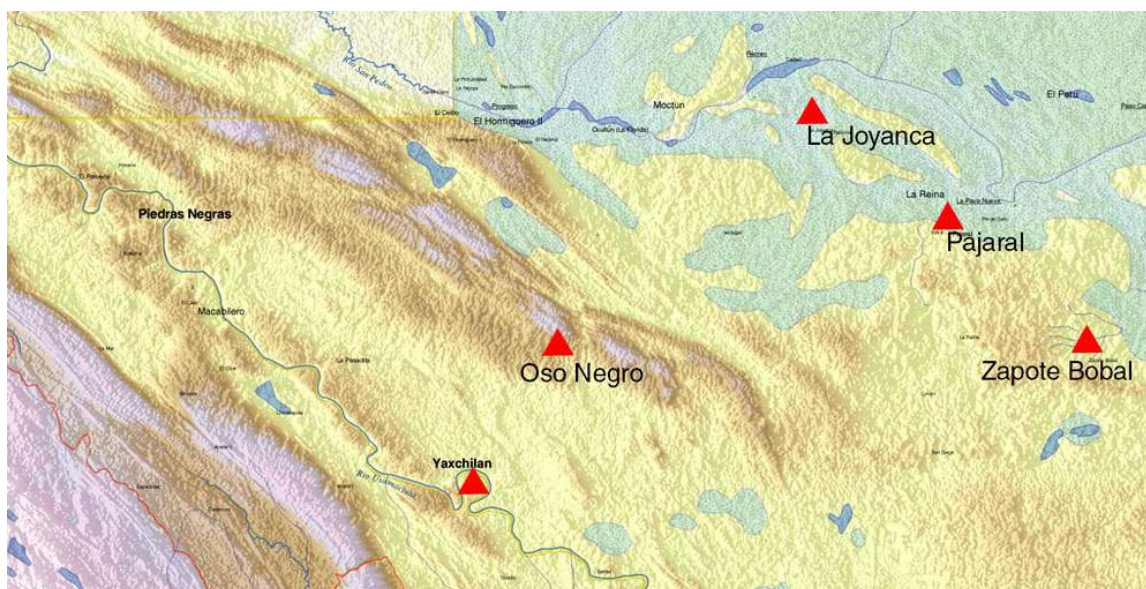


Figure 16. Location of predicted secondary sites (indicated by "?") along Yaxchilán's northern border.

Aside from being located near Yaxchilán's northern border, there are other significant aspects to Oso Negro's location. The site is located on the edge of a bajo, near the foothills of the Sierra del Lacandón. Thus, the site appears to be situated to take advantage of potential agricultural terrain. However, Oso Negro is also strategically located near a pass that leads through the Sierra del Lacandón to the sites of La Joyanca, Pajaral, and Zapote Bobal, now known to comprise the ancient kingdom of Hix

Witz (Breuil-Martinez, *et al.* 2004) ([Figure 17](#)). In fact this same route was used as a *trocopas* (logging road) in the early part of the 20th century and is still used today as an overland route by inhabitants of the modern town of Naranjo to illegally enter the Sierra del Lacandón for illicit activities such as looting and to cut *xate* (a plant used in floral arrangements in the United States).

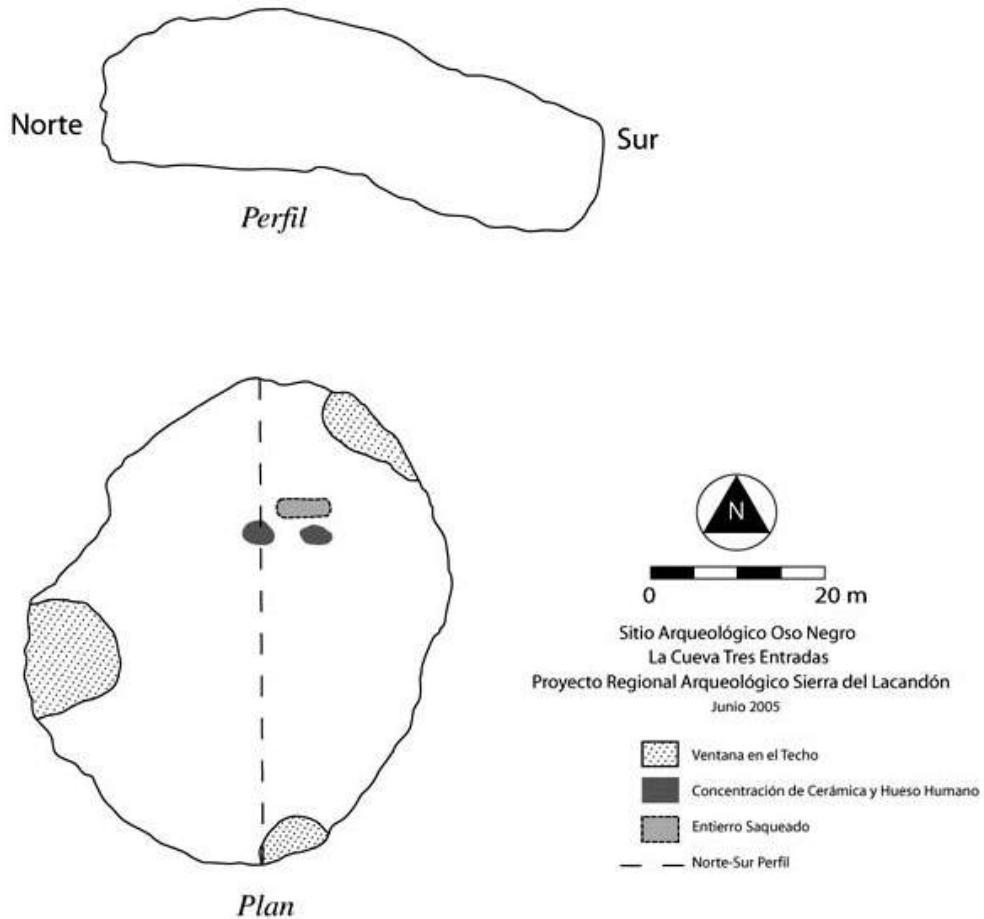


**Figure 17. Location of Oso Negro near a pass in the Sierra del Lacandón leading to the sites of the Hix Witz kingdom (La Joyanca, Pajara, and Zapote Bobal).**

Further evidence for the strategic positioning of Oso Negro comes from reconnaissance in the foothills to the north of the site. During this survey, members of the SLRAP encountered isolated mounds atop some of the tallest peaks. It is unlikely that these isolated structures served as residences for rural farmers considering their distance from arable land and the difficult climb necessary to reach the top of these hills. Rather, these sites likely served as observational outposts. In fact, atop at least one of these hills it was possible to see Yaxchilán in the distance ([Figure 18](#), shown below), though unfortunately this photograph was taken with a digital camera not equipped with a zoom lens.



**Figure 18. View of Yaxchilán from a hilltop north of Oso Negro. Yaxchilán can be seen as the white structures in the clearing towards the left side of the image.**



**Figure 19. Map of the Cueva de Tres Entradas, Petén, Guatemala.**

### **Cueva de Tres Entradas**

Atop a hill to the north of Oso Negro is a large cave known to local inhabitants as the Cueva de Tres Entradas. The cave is oval in shape, measuring 17 meters at its greatest width and with a ceiling 5 meters high (Figure 19). There are three openings in the roof of the cave, from which it derives its name (Figure 20a). The cave is entered by climbing down a long tree root in the western opening (Figure 20b). The floor of the cave consists primarily of loose rubble with some areas of exposed earth. The cave was dry and lacked stalactite and stalagmite formation.



**Figure 20a. Cueva de Tres Entradas. Southern cave wall.**



**Figure 20b. Cueva de Tres Entradas. Western cave opening.**

Near the northern end of the cave was a large concentration of human remains and ceramic sherds, presumably from a looted burial or a series of looted burials ([Figure 21](#), shown below). In general, the ceramic sherds are most similar to forms from the Central Petén and include a mix of primarily Late Preclassic and Early Classic materials ([Figure 22](#)). The human remains included skeletal elements of at least five individuals. This minimum number of individuals was based on the presence of left proximal ulna fragments from three different adults and skeletal elements from two subadults of different ages. Although there was no evidence of pathological or cultural modifications, the human remains had been burned.





Figure 21. Bone and ceramic concentration on the floor of the Cueva de Tres Entradas.

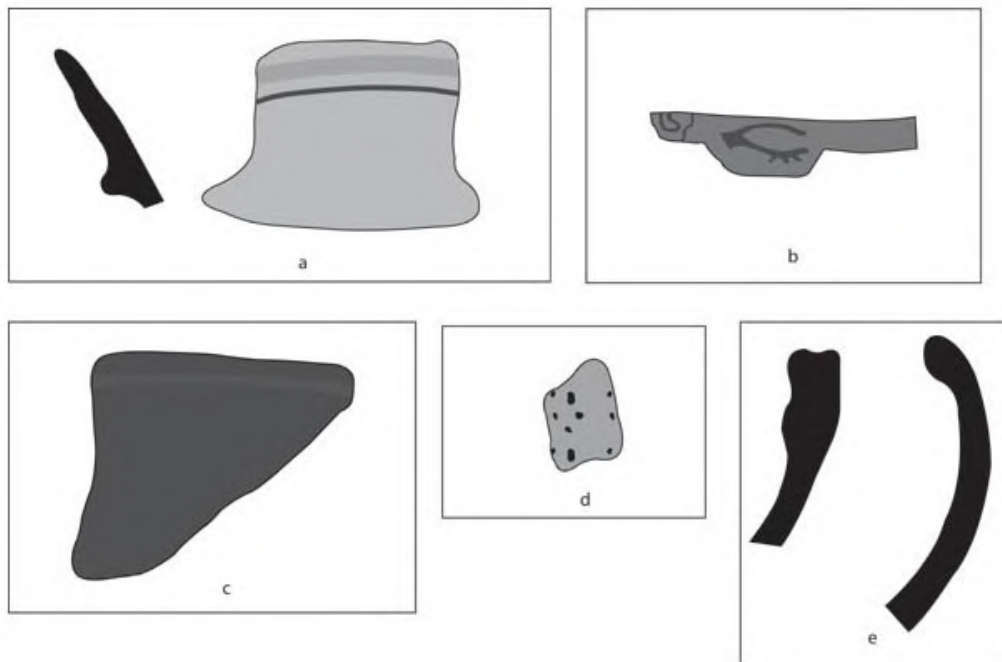
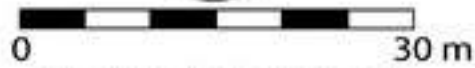
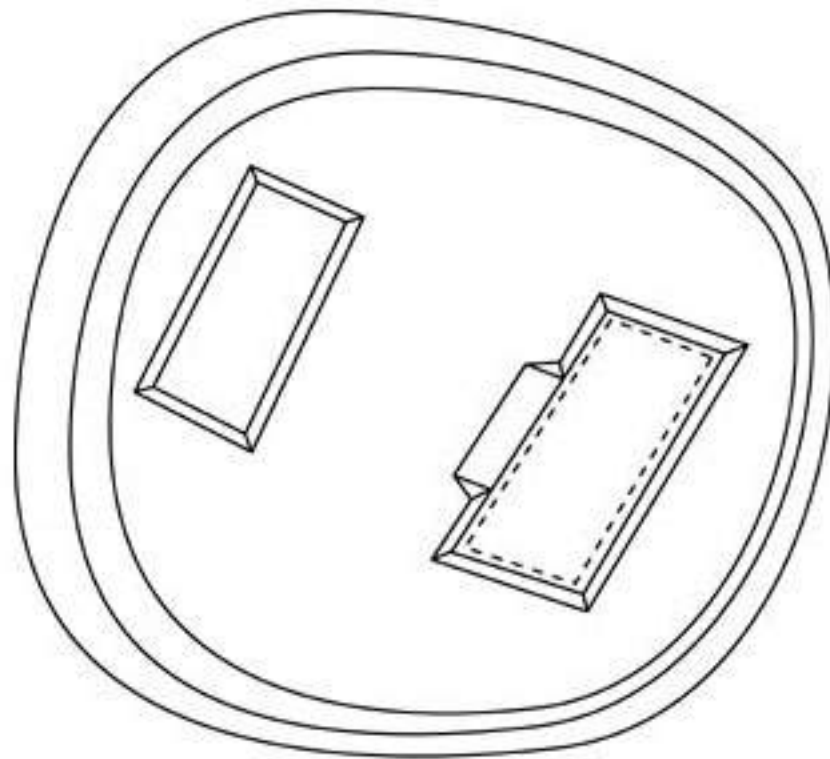


Figure 22. Sample of ceramic sherds recovered from the floor of the Cueva de Tres Entradas (drawing by Juan Carlos Meléndez).

## La Pasadita

While conducting reconnaissance, members of the SLRAP briefly visited the site of La Pasadita. Work at La Pasadita focused primarily on exploring both a heavily looted architectural group and a rockshelter. The architectural group was located near the center and was situated atop hill, which is typical of settlement at La Pasadita. The group consists of two platforms, one of which is topped by a collapsed vaulted structure ([Figure 23](#)). This mound was bisected by three major looter's trenches. In the northernmost looter trench we encountered an empty looted crypt ([Figure 24](#)). The crypt itself was finely made, with walls consisting of three courses of extremely well-cut stone, and topped with four large *lajas* ([Figure 25](#)). The crypt measured 0.30 meters high, 0.44 meters in width, and 2.4 m in length. The crypt was located below the floor of the northernmost room of the collapsed structure. Interestingly, despite thorough searching, no artifacts or human remains were encountered in the crypt nor in the looter's fill. In this regards, this looted crypt is similar to the looted crypt encountered below the floor of the northern room (Room 3) of Structure D3-1 (formally Structure 1) of Tecolote, which was also empty of human remains and artifacts ([Golden 2003b](#)). Although both of these crypts may have been completely cleaned out by looters, it is also possible that they were built but never used by the Maya.



Sitio Arqueológico La Pasadita  
Grupo Cripta  
Proyecto Regional Arqueológico Sierra del Lacandón  
Junio 2005



----- Superestructura

Figure 23. Map of the Crypt Group, La Pasadita, Petén, Guatemala.



**Figure 24. Looter's trench in the main structure of the Crypt Group, La Pasadita. Note the crypt to the archaeologist's left.**



**Figure 25. Interior view of looted crypt, Crypt Group, La Pasadita.**

To the northwest of La Pasadita's center, members of the SLRAP explored a rockshelter that was simply dubbed the "Three-Level Rock Shelter," for its form.

Ceramics were found scattered over the surface of the rock shelter. These sherds date from the Late Preclassic through Terminal Classic periods, which is typical of most caves in the Sierra del Lacandón (Golden, Romero, *et al.* 2005; Golden, *et al.* 2003; Muñoz 2004b). Interestingly, a natural rock outcrop at the entrance of the rock shelter appears to have been modified to serve as an altar. Above this altar were two steps cut from the bedrock floor of the rockshelter. From the altar, a hill descends to the forest floor four meters below. Thus, the rock shelter likely served as a stage for ritual activities.

## El Túnel

El Túnel was first visited by Edwin Román and René Muñoz of the SLRAP in 2004 (Golden, Romero, *et al.* 2005). Members of the SLRAP returned to the site in 2005 to use it as a base of operations in an attempt to reach the site of Tixan while avoiding the illegal community of Centro Campesino. While based at El Túnel, the team registered and generated sketch maps for a number of mound groups, the most significant of which are Túnel 09 and Túnel 12.

Túnel 09 consists of a small (about 4 meters high) pyramidal structure accompanied by a small mound as well as a large platform topped with a C-shaped mound and two other mounds (Figure 26). Túnel 12 is another large patio group that consists of a platform topped by a superstructure with standing walls (though apparently unvaulted) and a series of other mounds (Figure 27a and Figure 27b, shown below). As the most significant architecture at El Túnel, Túnel 09 and Túnel 12 may have been part of the site core. However, without more thorough reconnaissance, this cannot be determined with certainty.



Figure 26. Sketch map (not to scale) of Túnel 09, El Túnel, Petén, Guatemala.

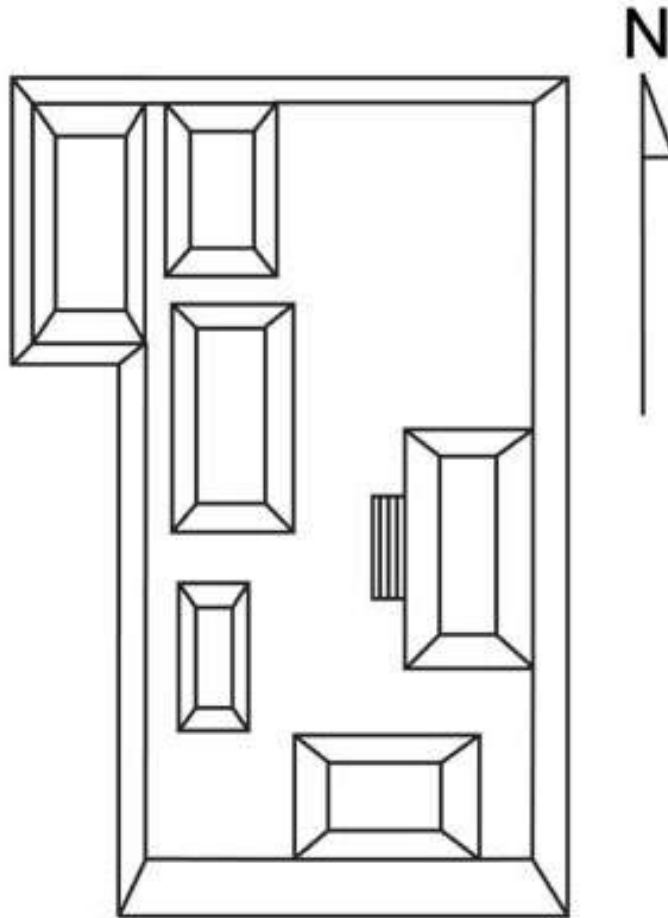


Figure 27a. Sketch map (not to scale) of Túnel 12, El Túnel, Petén, Guatemala.

Like Túnel 09 and Túnel 12, all of the mound groups at El Túnel consisted of formal plaza groups, most of which were located atop artificial platforms. Although surface ceramics were not encountered at El Túnel, this pattern of settlement conforms to what is known of Classic period settlement in the region. Further, the masonry work of the superstructure – a mix of small, fine flat slabs and larger cut stone – is quite similar to that of La Pasadita and Tecolote ([Figure 27b](#)). However, one notable difference between the sites is that settlement at El Túnel was focused primarily on flat terrain, whereas at Tecolote and La Pasadita the majority of mound groups are situated atop hills.



**Figure 27b. Superstructural wall of Túnel 12, El Túnel, Petén, Guatemala.**

El Túnel's similarity in architectural style and proximity to La Pasadita and Tecolote would suggest a possible political affiliation between them. However, a large wall structure measuring 1-1.5 meters high and 100 meters long was encountered midway between La Pasadita and El Túnel. Although the exact function of this construction is unknown, similar such features have been encountered in the vicinity of Tecolote and may have served as the bases for palisade walls (Golden, Scherer, *et al.* 2005: 12). If this is the case, it might suggest an antagonistic relationship between El Túnel and La Pasadita.

## Tixan

Although the identification and documentation of Tixan was the primary objective of this season's reconnaissance, the presence of illegal invaders at Centro Campesino made this impossible. However, after consultation with our guides, it was determined that portions of the area they know as Tixan could be reached safely from the north. Unfortunately, due to the length of time required to reach Tixan from this route, we were only able to spend one day conducting reconnaissance at the site. Nonetheless, we managed to document five different mound groups at Tixan ([Figure 28](#) and [Figure 29](#)).

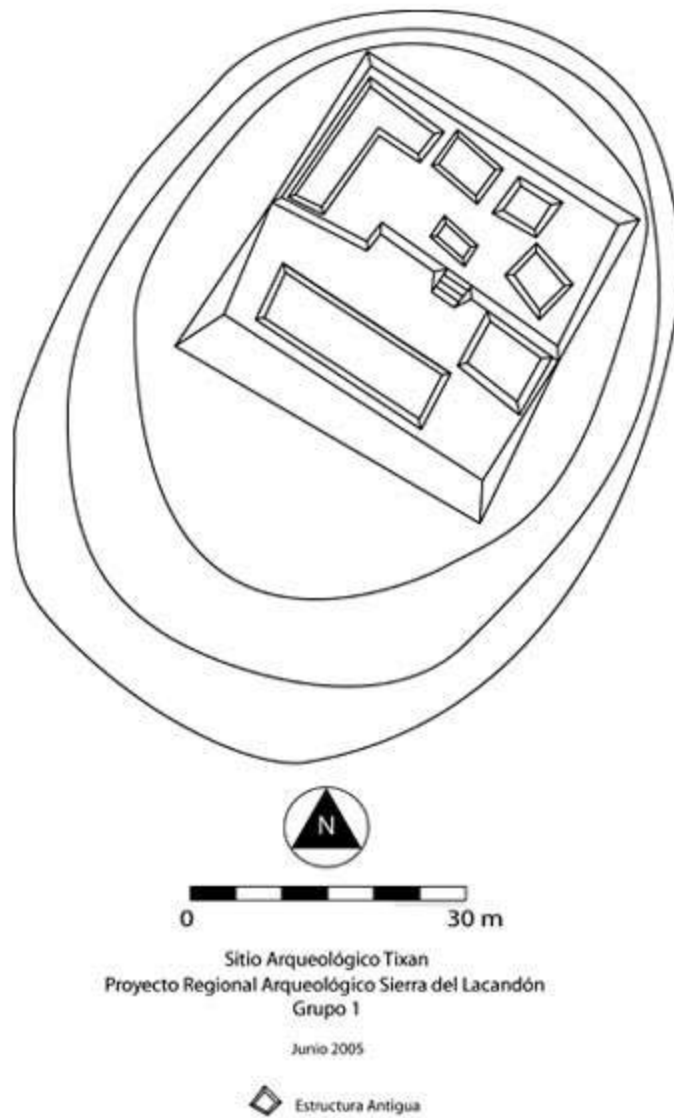
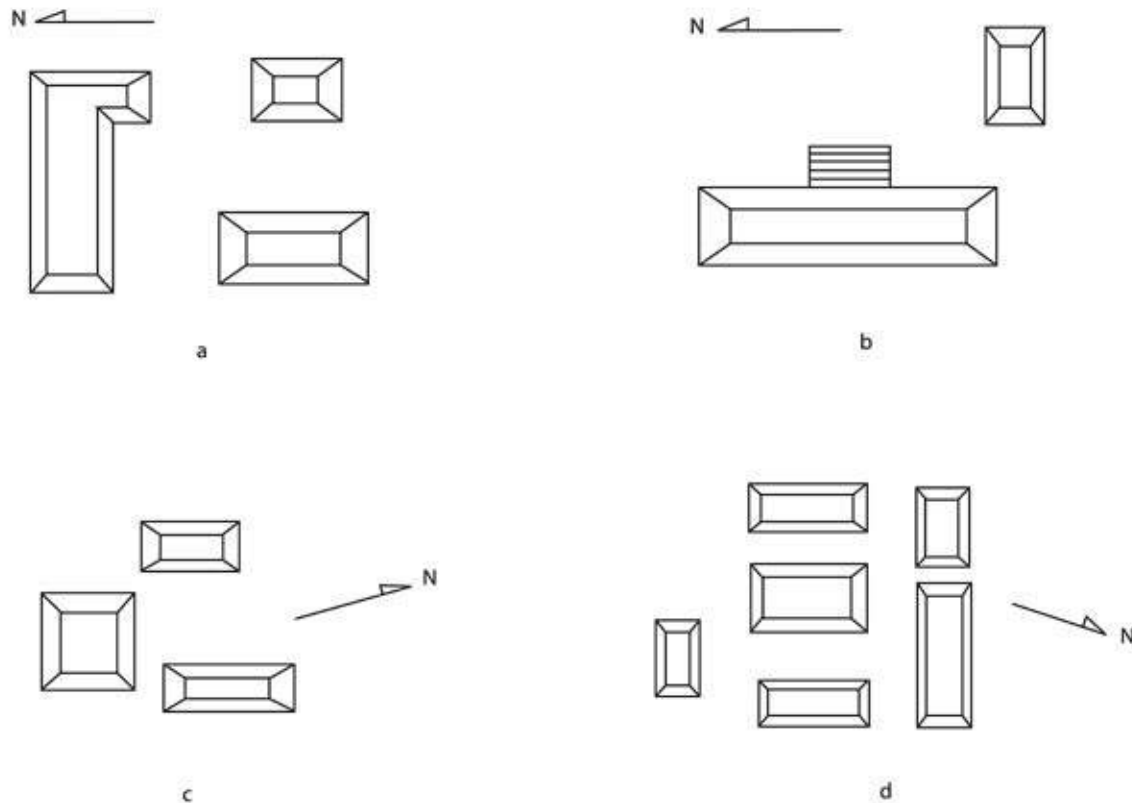


Figure 28. Map of Tixan 01, Tixan, Petén, Guatemala.





**Figure 29. Sketch maps (not to scale) of Tixan 02 (a), Tixan 03 (b), Tixan 04 (c), and Tixan 05 (d), Tixan, Guatemala.**

Of these five groups, we managed to make an EDM and compass map of Group 1. This group consists of a series of mounds atop two platforms. The two platforms are connected by a small staircase, with one platform situated above the other. The mounds of Group 1 are low, with a height of only 0.5 to 1.0 meters, and there was no evidence of superstructures. The other groups at Tixan were quite similar to Group 1.

Similar to Tecolote and La Pasadita, settlement at Tixan was on the hilltops. However, the masonry work is quite unlike that of Tecolote, La Pasadita, and El Túnel, and consisted of only large, roughly cut stone blocks with a complete absence of the small flat stone slabs that are typical of the masonry work at the other sites. However, without further reconnaissance it is impossible to say whether this is characteristic of all of Tixan, or only the northern portion of the site we visited.

Unfortunately, it is difficult to conclude much about Tixan based on this preliminary reconnaissance. At the present time, it is unclear whether the settlement we are calling Tixan is part of the same site that is reported to contain the monumental architecture, or if what we encountered was simply a large rural center to the north. When members of the Piedras Negras project traveled from Centro Campesino to La Pasadita in 1998,

they noted near-continuous settlement from Centro Campesino to La Pasadita (Golden, personal communication, 2005). If this is the case, then it certainly is possible that settlement from the site we visited leads to a large site core that we are certain exists to the south, closer to Yaxchilán, based on reports from the Defensores de la Naturaleza (see [The Future of the Sierra del Lacandón National Park](#)). Further reconnaissance is needed to confirm this possibility.

## **La Técnica**

The site of La Técnica is located in the modern community of the same name, on the Guatemalan side of the Usumacinta River. Community streets wind around some mounds, some structures have been destroyed by expansion of the town, and others currently serve as the foundation for modern buildings. The site of La Técnica corresponds to a series of mounds, between approximately 1 and 4 meters in height. La Técnica was first investigated by Paulino Morales, who reports that settlement is from the Late Preclassic through Early Classic periods (Morales 2001: 1). Ceramics found in road cuts by SLRAP members support this observation. Interestingly, one of the architectural groups corresponds to an "E Group" pattern, with a pyramid on the west side of a patio (Structure 4) and a long, two-leveled structure on the east (Structure 2) ([Figure 30](#)).

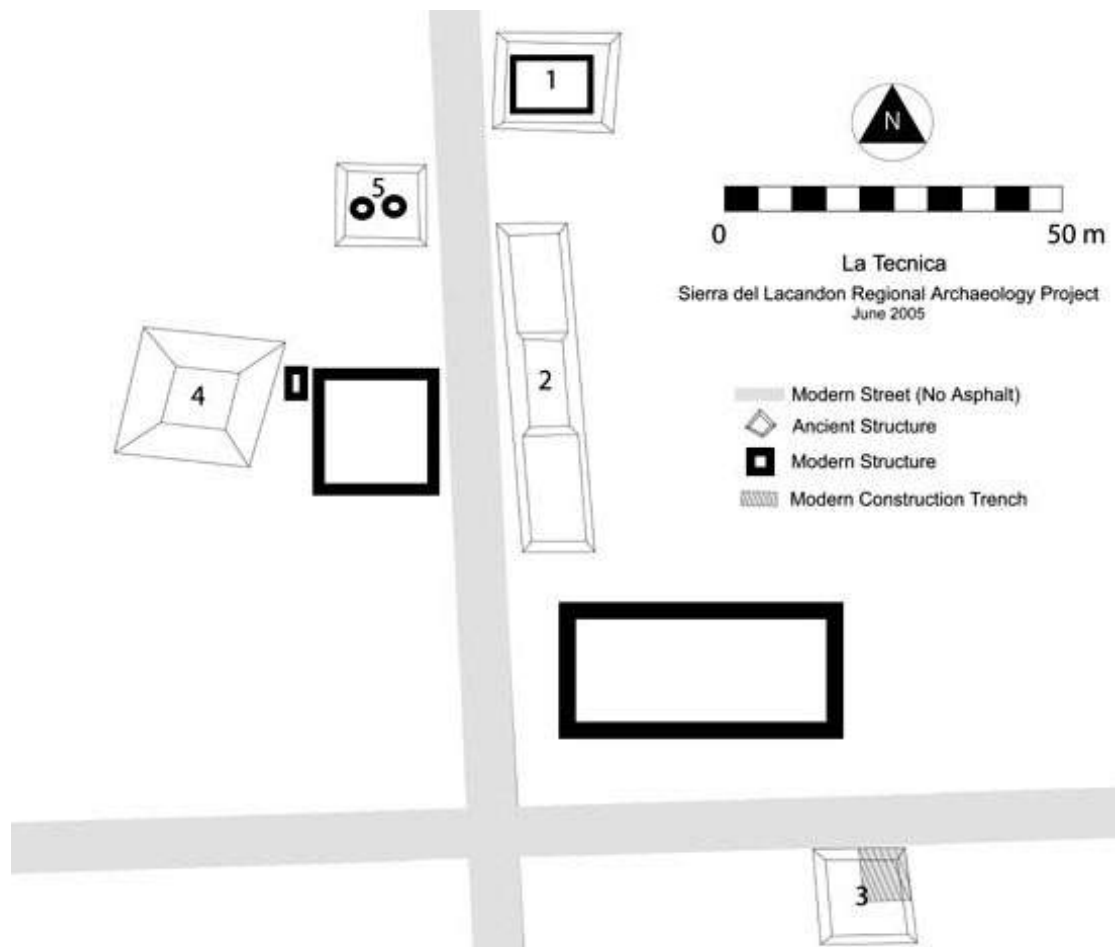


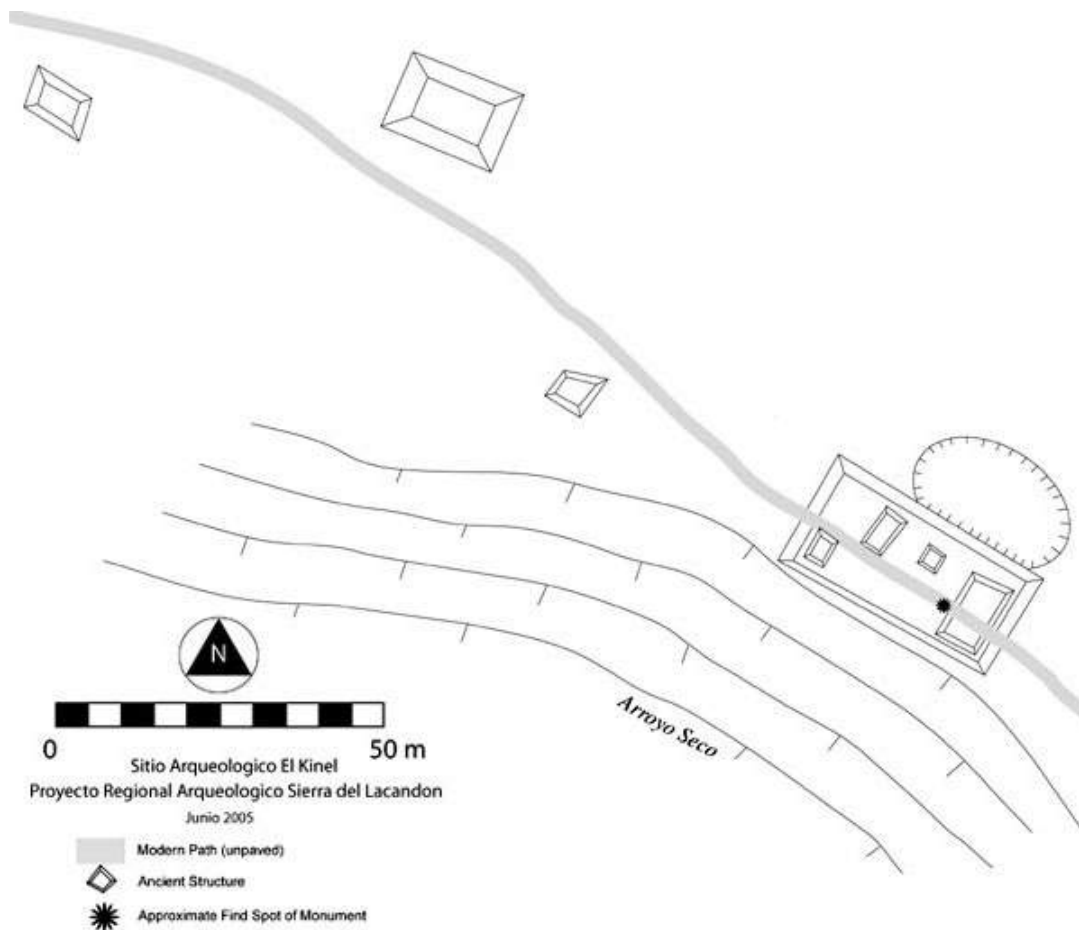
Figure 30. Map of the archaeological site of La Técnica, Petén, Guatemala.

It is not possible to ascertain the original form or extent of settlement in La Técnica, due to modern disturbance of the site, but it appears to represent a small Preclassic center that may have been of some local importance.

### El Kinel

The site of El Kinel is located in the agricultural fields two kilometers to the northwest of the modern community of La Técnica. El Kinel was formally identified in 1999, and investigated and documented by Paulino Morales in 2001 (Morales 2000a, 2000b, 2001). The majority of the mounds are between 1 and 2 meters tall, although some are as high as 4 m, and many are between 15 and 20 meters long. The largest platforms support patios of three or four perishable superstructures, with the largest platforms closest to the Usumacinta River. All architectural group names used here follow Morales' original designations.

During road construction in Group A of the North Sector of El Kinel in 1999, residents of La Técnica encountered a monument featuring the ruler of Yaxchilán. Group A consists of a modified escarpment that served as a platform topped with four low mounds (Figure 31). On the surface of Group A, members of SLRAP encountered large quantities of Fine Orange sherds, which date to the Late and Terminal Classic periods. Group A, like many of the architectural groups at El Kinel, featured an *aguada*. These were likely excavated by the ancient Maya to obtain construction materials for the architecture of El Kinel. Although the *aguadas* might have been used to hold water, this may have been unnecessary with the Usumacinta River only hundreds of meters away.



**Figure 31. Map of the North Sector, El Kinel, Guatemala. Group A is the platform on the eastern side of the map.**

The monument found in 1999 is currently housed in the community of La Técnica. The monument was initially registered and photographed by Morales. Héctor Escobedo (2001) completed a preliminary interpretation of the monument based on Morales' photographs. In order to permit a more detailed analysis of the monument, members of the SLRAP obtained permission from the leaders of La Técnica to extensively photograph the monument (Figure 32). At this point in time, it is unclear whether the

monument was a lintel or a stela. It is much thinner and narrower than any known lintel from the area. However, stylistically the monument does not follow with the normal Yaxchilán stela program in that the area above the central image is not carved (Stephen Houston, personal communication, 2005). Based on our photographic documentation, Stephen Houston is currently preparing a drawing and a full interpretation of the monument. Preliminary work indicates the monument features Shield Jaguar III (Houston, personal communication, 2005). Interestingly, the architectural group in which the monument was found is quite modest and there is no evidence that any of the structures were vaulted. Whether this was the original location of the monument, or if it had been moved to this group sometime later in antiquity is unclear at this time.



**Figure 32. Monument 1, La Técnica, Petén, Guatemala.**

## Discussion and Conclusions

The results of this season's reconnaissance in the southern area of the Sierra del Lacandón National Park have significantly improved our understanding of settlement within the Yaxchilán kingdom. Based on previous work by the SLRAP, we proposed that Tecolote and La Pasadita constituted the northern Late Classic border of the Yaxchilán kingdom (Golden, Scherer, et al. 2005). Both of these sites were secondary centers, and from the epigraphic record, we know with certainty that La Pasadita was ruled by a *sajal* subordinate to the *k'uhul ajaw* of Yaxchilán (Golden 2003a; Martin and Grube 2000: 124). However, prior to the work reported here, we lacked an understanding of settlement between the polity capital at Yaxchilán and the secondary centers along the northern border.

Based on three weeks of reconnaissance, we now know that settlement was dense in the Yaxchilán kingdom, as dense as anything encountered within the realm of Piedras Negras (Golden, Romero, et al. 2005; Golden, et al. 2003). Further, we have a general sense of the settlement hierarchy in the Yaxchilán kingdom. Following conventions established for cross-cultural studies of settlement hierarchy, settlement in the Yaxchilán kingdom can be divided into four levels (Marcus 2003: 103; 2004: 359). At the apex of this hierarchy was Yaxchilán itself. Secondary centers included La Pasadita, Tecolote, and Oso Negro. We know these sites were ruled by important nobles based on inscriptions from La Pasadita and Yaxchilán, as well as looted monuments from as of yet unknown sites in the area (Golden 2003a; Martin and Grube 2000). We know that the *sajal* had significant political functions (Culbert 1991; Houston and Stuart 2001; Parmington 2003; Schele 1991) and it is quite likely that they governed not only the secondary centers in which they lived, but administered nearby, lower-order sites as well. These *sajalooob* (*sajal*, pl.) were not only local governors, but were important military allies of Yaxchilán's rulers. The military function of the secondary centers ruled by the *sajalooob* is further underscored by the defensive nature of settlement at these sites, which is primarily located atop hills, and in some cases associated with probable defensive fortifications.

Based on observations in the Piedras Negras kingdom, tertiary centers would be expected to correspond to sites with a definable core of public architecture, but would nonetheless lack monumental architecture and associated inscriptions. At the fourth level were small rural agricultural hamlets with no definable site center.

Interestingly, defining tertiary and quaternary level centers is difficult in the Yaxchilán kingdom. For instance, settlement at Unión Maya Itza is extensive and would suggest it is a third order center, yet the lack of an obvious site core indicates a lack of an administrative node. El Túnel, with at least one small pyramidal structure, may constitute a tertiary center. Yet, the overall settlement size and density, as well as the quality of the masonry work, are more similar to what we know of the secondary centers. For El Túnel, there may exist an as yet unidentified monumental core for the site. Further, the presence of a probable defensive feature between El Túnel and La Pasadita, may indicate that El Túnel was not even part of the Yaxchilán kingdom. At El

Kinel, the density of settlement and quality of architecture would suggest a third order center, yet the presence of a monument featuring the ruler of Yaxchilán would indicate the site had a more significant function.

This confusion is in contrast to what has been found to date in the Piedras Negras kingdom, where differentiating between second, third, and fourth order centers is relatively straightforward (Golden, Roman, *et al.* 2005; Golden, Scherer, *et al.* 2005). This suggests that Yaxchilán and Piedras Negras may have had different settlement hierarchies and taken alternative approaches to political organization in their respective Late Classic kingdoms. Further, the distinction between tertiary and quaternary centers in the Yaxchilán kingdom may not even be valid. Rather, it is possible that all rural settlement in the Yaxchilán polity was administered from second order centers like Tecolote and La Pasadita. Clearly, further research is needed to clarify this issue.

Nonetheless, one way in which the Yaxchilán kingdom paralleled that of Piedras Negras was in its bimodal cycle of settlement (Golden, Scherer, *et al.* 2005: 15-16). The following scenario can be extrapolated from the available data, though it needs to be confirmed with more complete chronological information from additional sites. During the Late Preclassic, Yaxchilán was apparently a relatively insignificant center. At the same time, La Técnica demonstrates evidence of occupation during the Late Preclassic period and the early part of the Early Classic period, including civic ceremonial architecture. However, by the end of the Early Classic period, the site was apparently abandoned. We can speculate that in the Early Classic period, as Yaxchilán rose to power, the countryside around the site was almost entirely abandoned as people immigrated into the center, perhaps drawn by the appearance of dynastic rule at Yaxchilán. However, in the Late Classic period, populations returned to the countryside around Yaxchilán at sites such as Unión Maya Itza, La Técnica, and El Túnel. This emigration was possibly motivated by rising populations at the polity capital. At the same time, secondary centers were established at La Pasadita, Tecolote, and Oso Negro, all three of which apparently date exclusively to the 8th century A.D. A similar pattern has already been proposed for the Piedras Negras kingdom, for which more complete archaeological information is available ([Golden 2003b](#); Golden, Scherer, *et al.* 2005; Houston, *et al.* 2003).

Future investigations by the SLRAP will target excavations at secondary, tertiary, and rural centers in both the Yaxchilán and Piedras Negras kingdoms to clarify this settlement history. Specifically, we are interested in exploring changing processes of frontier and border formation within the Sierra del Lacandón and to determine whether control of land was an implicit desire for the lords of Yaxchilán and Piedras Negras. To do so, we will be examining changes in not only settlement histories, but community identities within the region. Finally, these data will be integrated with research in human osteology, zooarchaeology, and agronomy to clarify issues of resource production and redistribution within the Sierra del Lacandón.

## **The Future of the Sierra del Lacandón National Park**

When the SLRAP first began reconnaissance of the Sierra del Lacandón in 2003, the primary threat to the cultural patrimony of the national park, which includes the important Classic period capital of Piedras Negras, was a proposed dam project (Electricidad 2003a, 2003b; Wilkerson 2001). Fortunately, the dam project is currently on hold. Today, the park is under attack from a more imminent threat – the presence of illegal invaders who are settling the land, cutting down the forest, and are engaged in illicit activities such as drug trafficking and looting.

Although we managed to avoid invaders during our three week reconnaissance expedition, their presence was everywhere. Much of the site of Oso Negro has already been burned and will likely be cleared for *milpa* by next year. During our reconnaissance of La Pasadita, El Túnel, and Tixan, we encountered numerous *brechas* (small paths) recently cut through the forest. These *brechas* demarcate parcels of land for burning. If this invasion goes unchecked, it is likely that by next year most of the forest from the southern end of the park to the archaeological sites of La Pasadita and Tecolote will be destroyed. At this rate, it is only a matter of years before the entire forest, including the area around Piedras Negras, is lost.

In January of 2005, a team of Mexican jaguar researchers were temporarily taken hostage by armed gunmen near the archaeological site of Esmeralda, and were reported to be using Piedras Negras as a base of operations (Daniel 2005). It is believed that these assailants were narcotraffickers who have begun to operate out of the Sierra del Lacandón.

This spring, the Defensores de la Naturaleza and CONAP conducted an aerial reconnaissance of the park. During the flyover, they reported significant destruction of the forest on the southern end of the park. In the area of Centro Campesino, where the center of Tixan is reported to be located, they spotted a number of large structures (possibly with collapsed vaults) and at least one *sacbé*. Clearly, these invaders are settled directly over a significant archaeological site. During this flyover, they also reported an illegally cut runway in the vicinity of the archaeological site of Texcoco.

Currently, the administrators of the Sierra del Lacandón National Park are understaffed and underfunded to combat this dire situation. Now more than ever, the Defensores de la Naturaleza and CONAP need support, if the archaeological and cultural resources of the Sierra del Lacandón National Park are to be preserved for future generations.

## **Personnel of the 2005 Sierra del Lacandón Regional Archaeology Field Team**

### **Archaeologists:**

Andrew K. Scherer  
Charles W. Golden



Rosaura Vásquez  
Fabiola Quiroa  
Ana Lucía Arroyave  
Juan Carlos Meléndez  
Cassandra Mesick

**Guides:**

Sotero Antonio Sandoval Martínez  
Julián Aju Yotz  
Pánfilo Regino Hernández  
Ambrosio Hernández Ixcayau

**Excavators:**

Raymundo Abraham Escobar Paz  
Elder Leonel Escobar Paz

**Acknowledgements**

The SLRAP would like to thank the Defensores de la Naturaleza, especially Javier Márquez and Héctor Monroy, for all of the support and advice that has made this work possible. We would also like to thank the Instituto de Antropología e Historia (IDAEH) of Guatemala and the Consejo Nacional de Áreas Protegidas (CONAP) for the permission to conduct research in the Sierra del Lacandón National Park.

The SLRAP is indebted to the communities of Unión Maya Itza, La Técnica, and Retalteco for permitting us to conduct research in their communities and supplying us with logistical support in the form of guides. In particular, we would like to acknowledge the leaders of Unión Maya Itza for arranging lodging and transportation to their community.

The SLRAP would like to graciously acknowledge the financial support of FAMSI, which made all of this work possible.

**List of Figures**

[Figure 1](#). Archaeological Map of the Sierra del Lacandón after three years of reconnaissance by the Sierra del Lacandón Regional Archaeology Project.

[Figure 2](#). Proposed location of the archaeological site of Tixan (red) and location of the invaders from Centro Campesino (blue).

[Figure 3](#). Map of modern communities in the vicinity of the Sierra del Lacandón National Park, Petén, Guatemala. The borders of the park are shown by the solid black line.

[Figure 4a](#). Looted monument fragment recovered in the community of Retalteco, Petén, Guatemala (photograph by Charles Golden).

[Figure 4b](#). Looted monument fragment recovered in the community of Retalteco, Petén, Guatemala (drawing by Stephen Houston).

[Figure 5](#). Modern community of Unión Maya Itza, Petén, Guatemala.

[Figure 6](#). Map of the archaeological site of Unión Maya Itza, Petén, Guatemala.

[Figure 7](#). Profiles of ceramic sherds recovered on the surface of Unión Maya Itza (drawing by Ana Lucía Arroyave).

[Figure 8](#). Mound 1, Alacran Group, Unión Maya Itza. The archaeologist in the foreground is inside of a looter's trench.

[Figure 9](#). Agricultural field north of the modern community of Unión Maya Itza. The archaeologist on the left is standing atop an archaeological mound.

[Figure 10a](#). Lacandón incensario recovered on the surface of Unión Maya Itza. Vessels matching the style of Figure 10a are often referred to as "god pots."

[Figure 10b](#). Lacandón incensario recovered on the surface of Unión Maya Itza.

[Figure 11](#). Map of Oso Negro, Petén, Guatemala.

[Figure 12](#). Southeast doorway of the Las Puertas Palace, Oso Negro. Note the doorway is filled with debris, giving the appearance that it was not constructed to full height.

[Figure 13](#). Painted red lines on the lintel above the southeast doorway of the Las Puertas Palace, Oso Negro.

[Figure 14](#). Profile of the staircase on the eastern façade of the Las Puertas platform, Oso Negro.

[Figure 15](#). Profiles of ceramic sherds recovered on the surface of Oso Negro (drawing by Ana Lucía Arroyave).

[Figure 16](#). Location of predicted secondary sites (indicated by "?") along Yaxchilán's northern border.

[Figure 17](#). Location of Oso Negro near a pass in the Sierra del Lacandón leading to the sites of the Hix Witz kingdom (La Joyanca, Pajaral, and Zapote Bobal).

[Figure 18](#). View of Yaxchilán from a hilltop north of Oso Negro. Yaxchilán can be seen as the white structures in the clearing towards the left side of the image.

[Figure 19](#). Map of the Cueva de Tres Entradas, Petén, Guatemala.

[Figure 20a](#). Cueva de Tres Entradas. Southern cave wall.

[Figure 20b](#). Cueva de Tres Entradas. Western cave opening.

[Figure 21](#). Bone and ceramic concentration on the floor of the Cueva de Tres Entradas.

[Figure 22](#). Sample of ceramic sherds recovered from the floor of the Cueva de Tres Entradas (drawing by Juan Carlos Meléndez).

[Figure 23](#). Map of the Crypt Group, La Pasadita, Petén, Guatemala.

[Figure 24](#). Looter's trench in the main structure of the Crypt Group, La Pasadita. Note the crypt to the archaeologist's left.

[Figure 25](#). Interior view of looted crypt, Crypt Group, La Pasadita.

[Figure 26](#). Sketch map (not to scale) of Túnel 09, El Túnel, Petén, Guatemala.

[Figure 27a](#). Sketch map (not to scale) of Túnel 12, El Túnel, Petén, Guatemala.

[Figure 27b](#). Superstructural wall of Túnel 12, El Túnel, Petén, Guatemala.

[Figure 28](#). Map of Tixan 01, Tixan, Petén, Guatemala.

[Figure 29](#). Sketch maps (not to scale) of Tixan 02 (a), Tixan 03 (b), Tixan 04 (c), and Tixan 05 (d), Tixan, Guatemala.

[Figure 30](#). Map of the archaeological site of La Técnica, Petén, Guatemala.

[Figure 31](#). Map of the North Sector, El Kinel, Guatemala. Group A is the platform on the eastern side of the map.

[Figure 32](#). Monument 1, La Técnica, Petén, Guatemala.

## Sources Cited

- Breuil-Martinez, V., L. Gamez, J. Fitzsimmons, J.P. Metailie, E. Barrios and E. Roman  
2004 "Primeras Noticias de Zapote Bobal, Una Ciudad Maya Clasica del Norocidente de Petén, Guatemala." In *Mayab* 17(61-83).
- Culbert, T.P.  
1991 "Maya Political History and Elite Interaction: A Summary View." In *Classic Maya Political History*, edited by T.P. Culbert, pp. 311-346. School of American Research Advanced Seminar Series. Cambridge University Press, Cambridge.
- Daniel, F.J.  
2005 "Drug Traffickers Invade Mayan City in Guatemala." In *Reuters*, February 25, Guatemala City.
- Electricidad, C.F.d.  
2003a *P.H. Boca del Cerro, Tabasco/Chiapas: Arqueología*. Subdirección de Construcción, y Coordinación de Proyectos Hidroelectricos, México, D.F.  
2003b *Proyecto Boca del Cerro*. Dirección de Proyectos de Inversión Financiada, Subdirección de Construcción, y Coordinación de Proyectos Hidroelectricos, México, D.F.
- Escobedo, H.L.  
2001 "Anexo I: Notas Sobre El Monumento de La Cooperativa Técnica Agropecuaria, La Libertad, Petén." In *Prospección Arqueológica del Sitio El Kinel, La Libertad Petén: Temporada 2001*, edited by P. Morales, pp. 14-15. Informe Final Entregado al Instituto de Antropología e Historia, Guatemala City.
- Golden, C.W.  
2003a "The Politics of Warfare in the Usumacinta Basin: La Pasadita and the Realm of Bird Jaguar." In *Ancient Mesoamerican Warfare*, edited by M.K. Brown and T. Stanton, pp. 31-48. Alta Mira Press, Walnut Creek, CA.  
2003b "[Sierra del Lacandón Regional Archaeology Project: First Field Season 2003](#)." Grant #02020. Final Report submitted to the Foundation for the Advancement of Mesoamerican Studies, Inc.

- Golden, C.W., E. Roman, A.R. Muñoz, A.K. Scherer and L. Romero  
 2005 "Reconocimiento y Patrones de Asentamiento en La Sierra del Lacandón." In *XVIII Simposio de Investigaciones Arqueológicas en Guatemala*, edited by J.P. Laporte, B. Arroyo and H. Mejía, pp. 293-303. Museo Nacional de Arqueología y Etnología, Guatemala City.
- Golden, C.W., L.A. Romero, K.A. Dardón and M. Rangel (editors)  
 2005 *Proyecto Regional Arqueológico Sierra del Lacandón, Informe Preliminar No. 2, Segunda Temporada 2004*. Informe Entregado al Instituto de Antropología e Historia de Guatemala (IDAEH), Guatemala City.
- Golden, C.W., A.K. Scherer and A.R. Muñoz  
 2005 "Exploring the Piedras Negras-Yaxchilán Border Zone: Archaeological Investigations in the Sierra del Lacandón, 2004." In *Mexicon XXVII*(1):11-16.
- Golden, C.W., M. Zamora, A.R. Muñoz, K.D. Johnson, E. Roman, A.K. Scherer and F. Scatena  
 2003 *Proyecto Regional Arqueológico Sierra del Lacandón, Informe Preliminar No. 1, Primera Temporada 2003*. Informe Entregado al Instituto de Antropología e Historia de Guatemala (IDAEH).
- Houston, S.D., H. Escobedo, M. Child, C. Golden and R. Muñoz  
 2003 "The Moral Community: Maya Settlement Transformation at Piedras Negras, Guatemala." In *The Social Construction of Ancient Cities*, edited by M. Smith, pp. 212-253. Smithsonian Institution Press, Washington, D.C.
- Houston, S.D. and D. Stuart  
 2001 "Peopling the Classic Maya Court." In *Royal Courts of the Ancient Maya, Volume 1: Theory, Comparison, and Synthesis*, edited by T. Inomata and S.D. Houston, pp. 54-83. Westview Press, Boulder, CO.
- Lopez-Varela, S.  
 1989 *Análisis y Clasificación de la Cerámica de un Sitio Maya del Clásico: Yaxchilán, México*. British Archaeological Reports, International Series, 535.
- 1992 "Ceramic Units from Yaxchilán, Chiapas, México." In *Cerámica de Cultura Maya* 16:18-21.
- 1994 "El Analisis Ceramico de Yaxchilán y Pomoná: Un Ejemplo para Entender la Estructura Economica y Politica en la Zona del Usumacinta." In *Modelos de Entidades Politicos Mayas*, edited by S. Trejo, pp. 183-207. Instituto Nacional de Antropología e Historia, México City.

- 1995 "El Análisis de la Cerámica de Pomoná y Yaxchilán: una Nueva Problemática en las Tierras Bajas Noroccidentales." In *Memorias del Segundo Congreso Internacional de Mayistas*, pp. 613-23. Universidad Nacional Autónoma de México, Instituto de Investigaciones Filológicas, México City.
- Maler, T.
- 1903 *Researches in the Central Portion of the Usumatcintla Valley*. Memoirs of the Peabody Museum of American Archaeology and Ethnology, Vol. 2, No. 2. Harvard University, Cambridge.
- Marcus, J.
- 2003 "Recent Advances in Maya Archaeology." In *Journal of Archaeological Research* 11(2):71-148.
- 2004 "Primary and Secondary State Formation in Southern Mesoamerica." In *Understanding Early Classic Copán*, edited by E.E. Bell, M.A. Canuto and R.J. Sharer, pp. 357-373. University Museum of the University of Pennsylvania, Philadelphia.
- Martin, S. and N. Grube
- 2000 *Chronicle of the Maya Kings and Queens*. Thames and Hudson, New York.
- Morales, P.
- 2000a *Registro de Estela 1, de El Kinel, La Libertad, Petén*. Informe presentado al Instituto de Antropología e Historia, Guatemala City.
- 2000b "Sitios Arqueológicos de Reciente Descubrimiento en Los Municipios de San Andrés y La Libertad, Petén." In *XIV Simposio de Investigaciones Arqueológicas en Guatemala*, edited by J.P. Laporte and H.L. Escobedo. Museo Nacional de Arqueología y Etnología, Guatemala City.
- 2001 *Prospección Arqueológica del Sitio El Kinel, La Libertad, Petén: Temporada 2001*. Informe Entregado al Instituto de Antropología e Historia, Guatemala City.
- Muñoz, A.R.
- 1999 "Análisis de Cerámica: Temporada 1999." In *Proyecto Arqueológico Piedras Negras: Informe Preliminar No. 3, Tercera Temporada 1999*, edited by H.L. Escobedo and S.D. Houston, pp. 347-358. Proyecto Arqueológico Piedras Negras, Guatemala City.

- 2000 "Análisis de Cerámica: Temporada de 2000." In *Arqueológico Piedras Negras: Informe Preliminar No. 4, Cuarto Temporada 2000*, edited by H.L. Escobedo and S.D. Houston. Proyecto Arqueológico Piedras Negras, Guatemala City.
- 2004a "[The Ceramic Sequence of Piedras Negras, Guatemala: Types and Varieties.](#)" Grant #02055. Final Report submitted to the Foundation for the Advancement of Mesoamerican Studies, Inc.
- 2004b "Proyecto Regional Arqueológico Sierra del Lacandón: Estudio Cerámico 2004." In *Proyecto Arqueológico Parque Nacional Sierra del Lacandón, Piedras Negras 2004, Informe 2, Temporada 2004*, edited by C.W. Golden, L. Romero, K. Dardón and M. Rangel. Dirección General del Patrimonio Cultural y Natural de Guatemala, Guatemala City.
- Palka, J.W.
- 2005 *Unconquered Lacandón Maya: Ethnohistory and Archaeology of Indigenous Culture Change*. University Press of Florida, Gainesville.
- Parmington, A.
- 2003 "Classic Maya Status and the Subsidiary "Office" of Sajal: A Comparative Study of Status as Represented in Costume and Composition in the Iconography of Monuments." In *Mexicon XXV*:46-53.
- Schele, L.
- 1991 "An Epigraphic History of the Western Maya Region." In *Classic Maya Political History: Hieroglyphic and Archaeological Evidence*, edited by T.P. Culbert, pp. 72-101. School of American Research Advances Seminar Series. Cambridge University Press, Cambridge.
- Wilkerson, S.
- 2001 "Usumacinta River Dams Project." In *Archaeology of Ancient México and Central America: An Encyclopedia*, edited by S.T. Evans and D. Webster, pp. 791-792. Garland, New York.