

FAMSI © 2009: Vilma Fialko

The Map of the Southwest Periphery of Naranjo, Petén, Guatemala

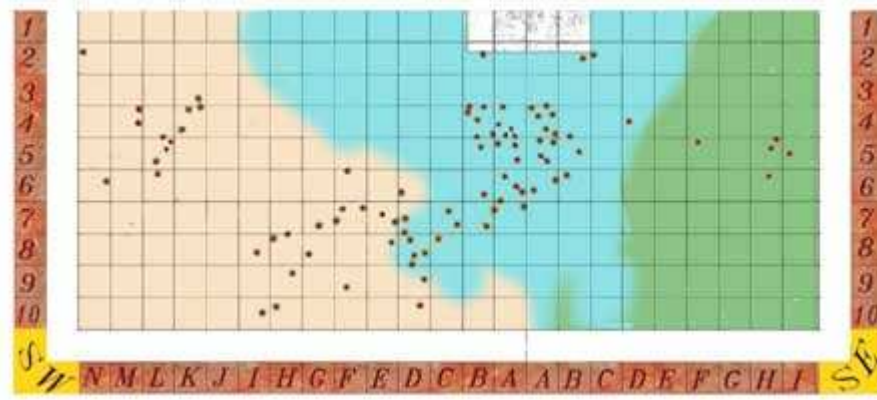

Research Year: 2006

Culture: Maya

Chronology: Early Classic, Late Classic, and Terminal Classic

Location: Petén, Guatemala

Site: Naranjo

Table of Contents

[The settlement of the residential periphery of the southwest zone of Naranjo, Petén](#)

[Background](#)

[Natural Environment](#)

[Naranjo's Southwest Periphery](#)

[Settlement in Naranjo's Southwest Periphery](#)

[Survey and the Map of Naranjo's Southwest Periphery](#)

[Characteristics of Settlement in Naranjo's Southwest Periphery](#)

[Final Remarks](#)

[Acknowledgments](#)

[List of Figures](#)

[Sources Cited](#)

Description of settlement groups in the southwest periphery of Naranjo, Petén

[Appendix 1.](#) Groups and maps of the Manantiales Central zone

[Appendix 2.](#) Groups and maps of the Manantiales Western zone

[Appendix 3.](#) Groups and maps of the Manantiales Eastern zone

[Appendix 4.](#) Groups and maps of the Bajo La Pita Este (East)

[Appendix 5.](#) Groups and maps of the Bajo La Pita Sur (South)

[Appendix 6.](#) Groups and maps of the Bajo La Pita Oeste (West)

The settlement of the residential periphery of the southwest zone of Naranjo, Petén

Vilma Fialko, Adriana Segura, Cyril Giorgi and Rafael Cambranes
Project of Archaeological Research and Rescue in Naranjo (PIAREN)

Background

Naranjo is located within the Yaxhá-Nakum-Naranjo National Park, a mere 10 km from the border between Guatemala and Belize. Because of its location, this important site has been the object of ongoing predation, and the looted objects have been easily trafficked through the border ([Figure 1](#)).

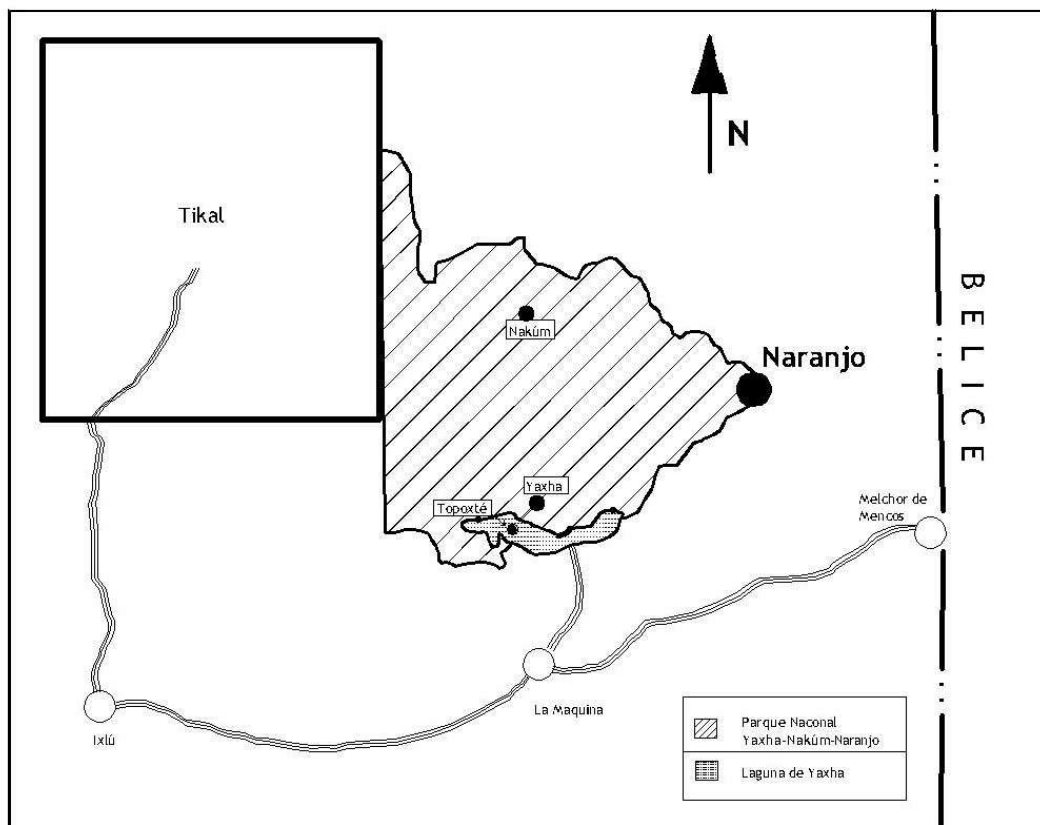

Figure 1. Location of Naranjo archaeological site (Triangle and Belize map).

Throughout 2002-2004 thanks to the archaeological rescue program sponsored by IDAEH with support from Germany, it was possible to record 74 tunnels and trenches, which amount to 28% of the existing damages in Naranjo's monumental epicenter (Fialko et al. 2002, 2003, 2004). Although we considered

the possibility of extending the study of diagnosis and rescue toward the rest of the epicenter and part of the periphery, this goal was not possible because the Ministry of Culture and Sports did not have the necessary resources. In light of this situation, in order to avoid the collapse of major tunnels and trenches which were not evaluated, we thought it would be convenient to provisionally close them down. We planted a particular kind of vegetation on the surface in order to have a clear reference for future identification and location.

Starting in 2005 the Project of Archaeological Research and Rescue in Naranjo (PIAREN) was organized. Thanks to several financial contributions this project has been able to carry on with the rescue process both in the epicenter and in the periphery. One of the first initiatives of the PIAREN project was to seek support from the World Monuments Fund, which responded favorably in 2005 by including Naranjo in the list of the 100 sites in most urgent need for rescue and conservation worldwide. Afterwards the PIAREN project started the study of two of the 12 tunnels found in the Central Acropolis, with Famsi's assistance and the participation of volunteer archaeologists, as well as the Department of Prehispanic Monuments, and workers provided by the General Directorate of Cultural and Natural Heritage (Fialko 2005). Likewise, the first surveys were conducted in the residential compounds located in the north and south peripheries. An immediate outcome of this was the confirmation of the huge degree of looting and damage to structures in virtually all plaza groups identified in the vast residential periphery.

In the current field season of 2006 we still had the logistical facilities and camp provided by Guatemala's Institute of Anthropology and History and the Yaxhá-Nakum-Naranjo National Park. We also had the participation of graduate students Cyril Giorgi (Sorbonne University, France), Alexander Tokovinine (Harvard University), as well as Guatemalan archaeologists Adriana Segura and Rafael Cambranes, who were assigned by the Department of Prehispanic and Colonial Monuments (IDAEH) to support the survey and mapping process. The IDAEH also contributed ten field workers who were trained for conducting survey and mapping work in Naranjo.

The Natural Environment

Naranjo is located in what can be considered the watershed of two great fluvial basins: the Holmul River and the Mopán River ([Figure 2](#)). Both basins were natural routes which integrated the Petén's Maya world with its Belizean counterpart, and eventually with the Caribbean coast. These routes were the backbone for Naranjo's process of sociopolitical expansion toward the northeast and southeast regions of the Petén. Some minor urban centers in Naranjo's support area or intrinsic territory appear to have been organized in micro basins connected with the Holmul and Mopán Rivers.

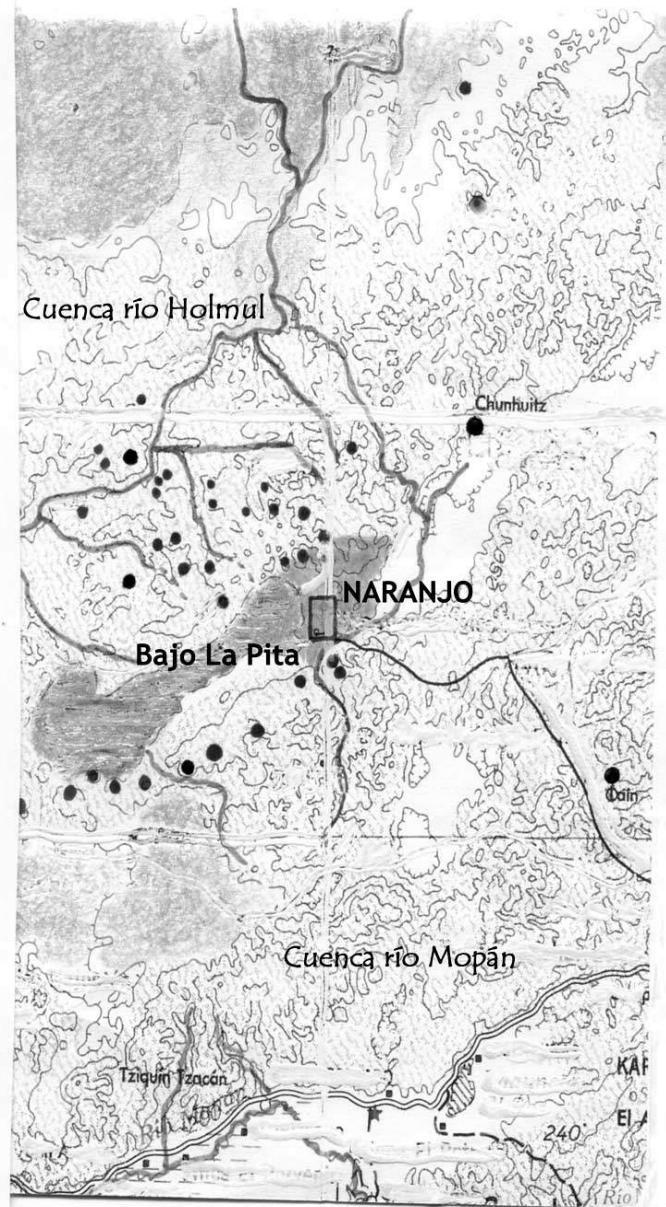

Figure 2. Naranjo's natural environment (basins plan).

Naranjo's monumental epicenter, as well as part of its residential peripheries, are guarded by a moderately abrupt system of hills, which is fragmented at its base by a system of gorges. These formations serve as a natural defense for the city, and trap the northern wind, which helps to produce a temperate climate which turns moderately cold between November and February. Some of the karstic elevations foster the accumulation of humidity in the Bajo La Pita, in whose eastern margin is located one of the *aguadas* (water reservoirs) which provided water to the epicenter. Other important water resources are six springs

associated to the peripheral residential area, located to the south of the monumental epicenter.

Naranjo's Southwest Periphery

Work conditions in Naranjo's southwest periphery are limited by the constant advance of the agricultural frontier. Every year the trespassing peasants start fires with the objective of increasing the areas for planting their fields. In 2004 one of the forest fires reached the foundations of the West Acropolis, also damaging an ancient Maya reservoir and canal which used to provide water to the city. The trespassers have been developing cattle raising and use Naranjo's springs as water sources for cattle, at present four springs have been depleted because of the construction of troughs.

Because of the impact of existing damage in the southwest periphery, survey and mapping activities have been initially concentrated in this sector, with the aim of having a clear knowledge of the amount, location and type of structures in risk of destruction. Another factor leading to the concentration of the first mapping works in Naranjo's southwest periphery is the location in this area of the site's main *aguada* (water reservoir), which is regarded as a vital resource for the long-term maintenance of the security and research personnel. The timely delimitation and control of these key sectors will help to diminish the pressure of the trespassers on this resource, which was also important in pre-Columbian times, as evidenced by the presence of Maya canals which took water from the reservoir to residential and agricultural areas.

At present Naranjo only has eight guards in the national park, who limit their inspections to the central monumental zone and the main access areas. One of the factors precluding a wider range for the guards is the lack of a map of Naranjo's periphery, a fundamental tool for creating a route which the guards can cover periodically, and for precisely locating the observed damages. In order to improve the inspection process the PIAREN project undertook the task of establishing different zones and drawing a geo-referenced map indicating spatially all structure groups in Naranjo's epicenter and periphery. This map has a geo-referenced grid system which will allow an adequate control of Naranjo's territorial space. Furthermore, it will also enable the creation of a convenient system of monitoring, control and security routes. This map will permit the assignation of a useful reference nomenclature for archaeological research purposes.

Naranjo's Southwest peripheral settlement

For an adequate interpretation and comparative analysis of the characteristics of settlement in Naranjo's southwest periphery, this area was divided in two parts: one pertaining to the Bajo La Pita and one related to the water springs associated with hills and gorges.

Part of the southern sector of the Bajo La Pita was partially explored in 1997, by means of a 20-km transect between Yaxhá and Naranjo, which was carried out in order to know the density and limits of peripheral settlements belonging to the aforementioned Maya cities ([Figure 3](#)). Since then the existence was defined of a dense, continuous settlement which is characterized by including plaza groups of an elite rank intermingled with domestic unit groups of a more modest nature (Fialko 1999). It has been determined that the territorial limits between Yaxhá and Naranjo are marked by the presence of minor urban centers, including temples and palace compounds which sometimes contain patios for the ball game and compounds of "Group-E" type. Naranjo's residential periphery associated with the southwest zone is bordered by the minor urban center known as La Tractorada, located at some 4.5 km from Naranjo's epicenter. In the south sub-zone of Bajo La Pita we found groups with evidence of Preclassic occupation, which confirms information previously gathered in Tikal's Bajo Santa Fe and in Bajo La Justa, between Yaxhá and Nakum (Fialko 1996, 2000). The bajos' environmental context is very important for knowing the settlement and subsistence patterns of the first inhabitants of the northeast region of the Petén.

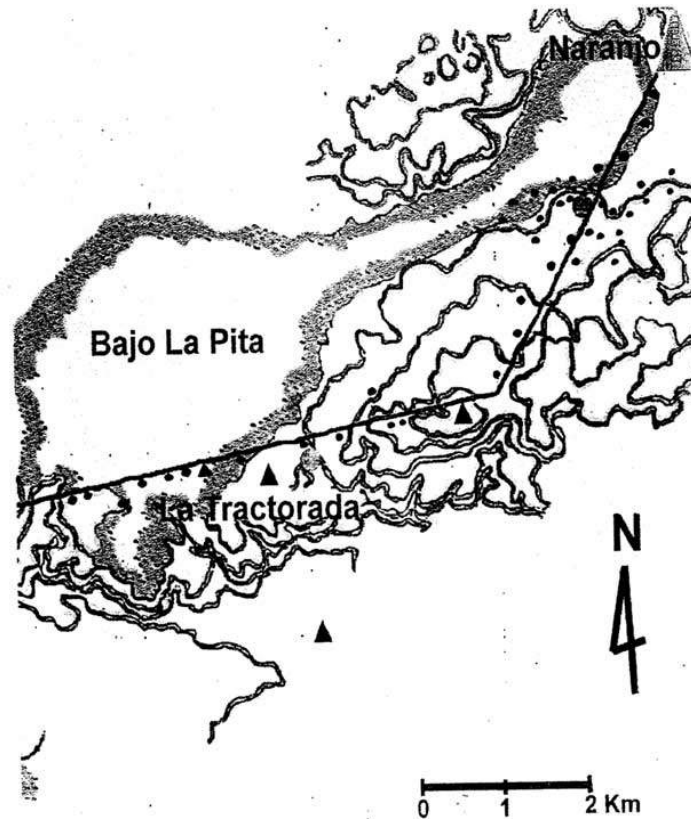

Figure 3. Yaxhá-Naranjo transect.

Survey and the Map of Naranjo's Southwest Periphery

The field activities for making the map of Naranjo's periphery were organized in the following phases:

1. Setting up a grid covering an area of 35 km² of the center and periphery (half of what is regarded as Naranjo's intrinsic space), with 250 m geo-referenced squares ([Figure 4](#)). This process was carried out using a total station.

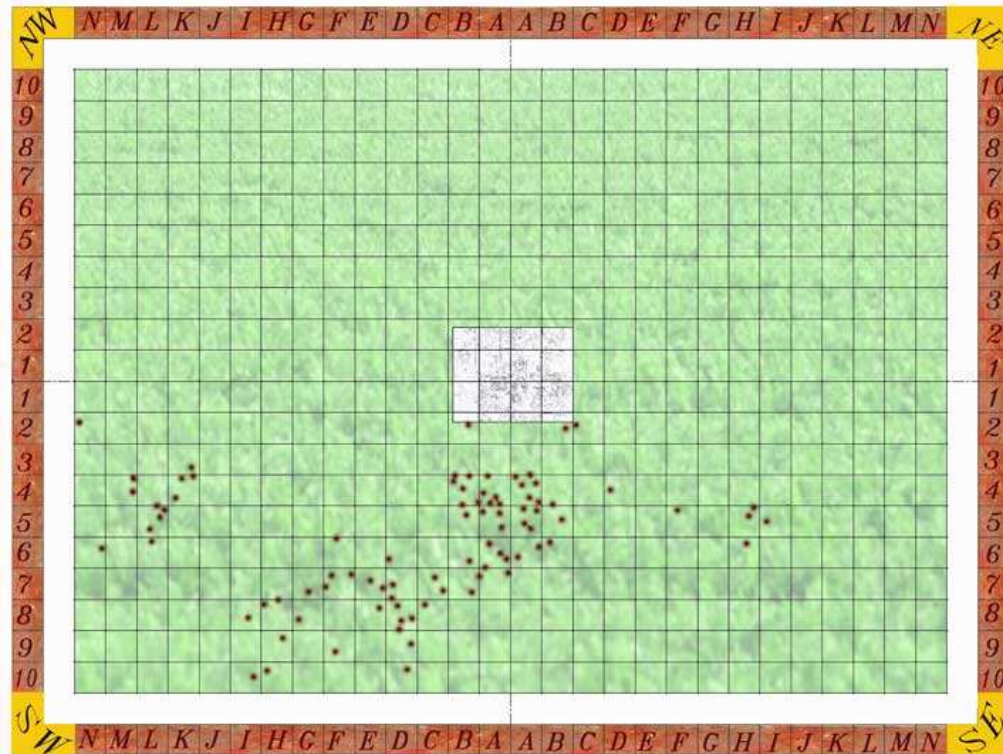

Figure 4. Map of quadrants of the southwest zone.

2. Conducting systematic surveys in a 25 km² area of the southwest residential periphery, guided by GPS, by a satellite image provided by NASA, and by cartographic sheets from the National Geographic Institute. This allowed us to know in advance the high density, formal characteristics, and conditions of the peripheral groups, as well as to determine the mapping logistics and methods to be used; these were based on GPS, Brunton compass and metric tapes.

3. Drawing maps of structure groups located in the sub-zones related to the Bajío La Pita, hills and springs. A total of 92 plaza groups were mapped, incorporating a total of 274 structures over an area of 9 km² which roughly corresponds with a third of the residential settlement of Naranjo's southwestern periphery ([Figure 5](#)).

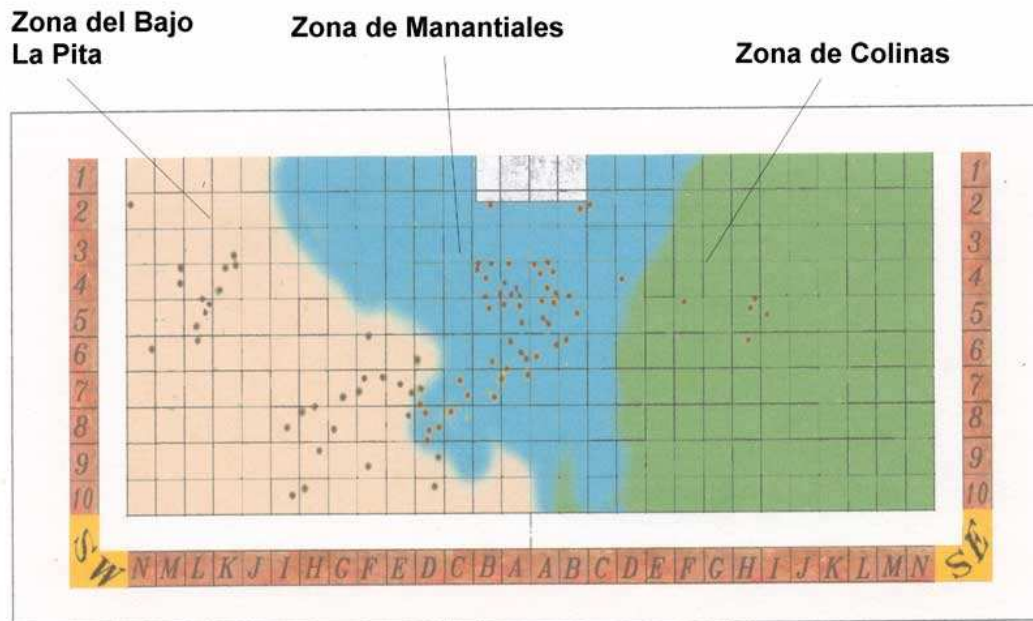

Figure 5. Map indicating the sub-zones.

4. Collection of samples of cultural materials linked to 160 looter's tunnels and trenches.

5. Analysis and cataloguing of samples of cultural materials.

Several work teams were organized, which worked simultaneously. One of them set up the segmented grid of half the space occupied by the southwest and northwest peripheries and the monumental archaeological zone (35 km²). In order to do this we proceeded to radiate with the total station from the main plaza in Naranjo's center, specifically from the NW corner of building B-18 (Temple of the Hieroglyph Stairway), where a BM was located during the process of making the map of Naranjo's monumental area.

Other two teams undertook the surveys, initially following existing truck roads, paths and footpaths. After incorporating the information found in the geographic maps, additional surveys were organized guided by GPS. A geo-referenced station was left in the center of each plaza group, which was later integrated in the general grid system registered by the total station. In order to facilitate the survey process and the input and processing of information which group was initially identified by random numbers, and then they were given field names. However, in the final report each group will appear with the number according to the quadrant of the grid in which it is located.

In order to establish the survey methodology and for the later classification of settlements, we took under consideration the environmental characteristics of the zones linked with the Bajo La Pita, as well as those pertaining to the hillocks and low hills which include the Manantiales (springs). With the aim of obtaining an adequate comparative analysis and interpretation of the characteristics of Naranjo's peripheral settlement, each of the aforementioned zones was subdivided in sub-zones, as discussed below:

1. Bajo La Pita Zone
 - 1.1. East Sub-Zone
 - 1.2. West Sub-Zone
 - 1.3. South Sub-Zone

2. Manantiales (springs) Zone
 - 2.1. East Sub-Zone
 - 2.2. Central Sub-Zone
 - 2.3. West Sub-Zone

Characteristics of Settlement in Naranjo's Southwest periphery

The south sub-zone of the Bajo La Pita is characterized by having a surface subject to flooding, which at present is covered by *corozo*, *escobo*, and *guano* palms. In the surrounding area there are small elevations with an altitude of 160 - 182 m asl. In these sectors one can see a dense settlement, in which 28 groups were mapped --a sample we regard as representing half the real occupation in this sub-zone. There is an overwhelming presence of non-elite residential groups with a "Plan Plaza 2" (PP2) plaza format. An outstanding feature seen in the East Sanctuary is a kind of rectangular foundation ([Figure 6](#)). We also found groups where some residential platforms show an orientation markedly slanted toward the northeast, apparently belonging to the Tepeu 3 phase, which also include sanctuaries with a rectangular plan, whose main façade corresponds with the building's narrower sector ([Figure 7](#)). Several groups of the south sub-zone of the Bajo La Pita include "L" shaped platforms ([Figure 6](#) and [Figure 10](#)). Domestic ceramics from the Terminal Classic period have been recovered from the lootings associated with these platforms, while some looting activities carried out in the sanctuaries located to the east have turned up polychrome sherds which could be associated with discarded materials from funerary offerings.



Figure 6. PP2 patio group and "L" shaped platform.

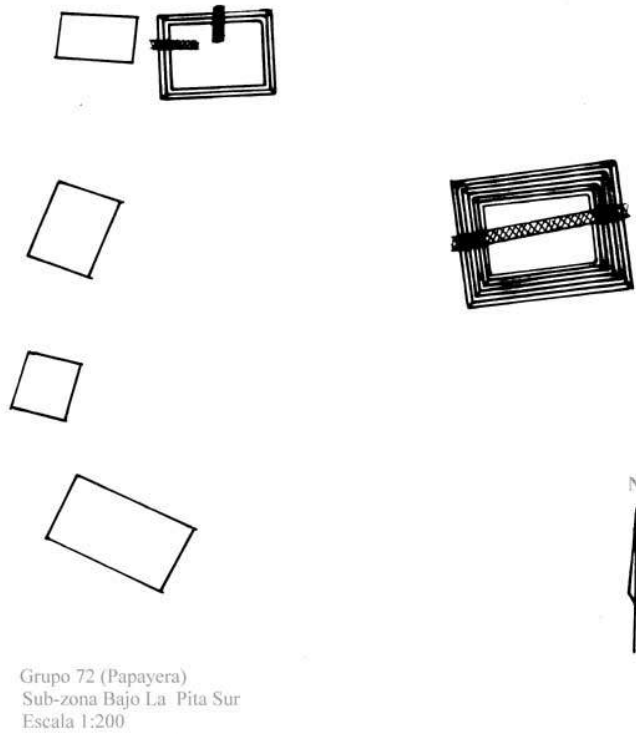

Figure 7. Informal plaza arrangement from the Terminal Classic period.

The east sub-zone of the Bajo La Pita pertains to an elite residential corridor neighboring the west zone of the monumental epicenter. The vegetation in the areas around the plazas is dominated by *corozo* palms, while in the terraces and on the top of structures there are trees such as *palo de Campeche* and *ramón*, associated with an altitude of 190-210 m asl. Fourteen groups were mapped in the east sub-zone. Most of them pertain to elite residential contexts, including palaces of several shapes, apparently representing families which were active in the monumental epicenter. Six groups were found in this sub-zone with "U" shaped buildings (Figure 8). This type of structure tend to be located in the north sector of the plaza, and they range from two to four meters in height. Four of the eight *chultunes* (storage pits) recorded in the whole of the east periphery were found in the east sub-zone of the Bajo La Pita. The preliminary analysis of the stratigraphy within the looted areas, as well as the cultural materials recovered, allow us to say that the buildings with the greatest construction volume had several building stages starting on the Tepeu 1 phase. Lootings showed the remains of graves, with materials showing an important occupation from the Terminal Classic.

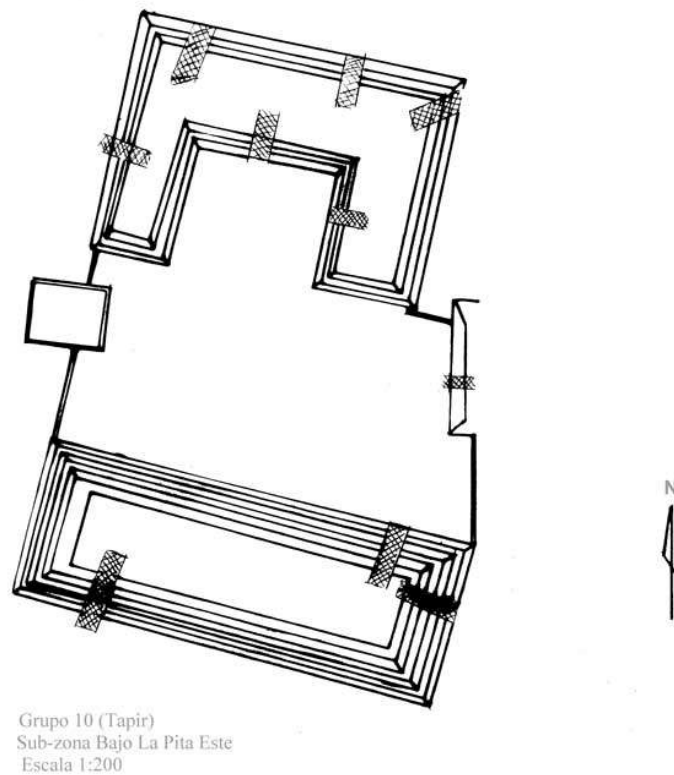

Figure 8. Quadrangle with "U" shaped structure.

The west sub-zone of the Bajo La Pita constitutes a topographic area of low hills (200-280 m asl), bordering with areas where there might have been agricultural terraces. Currently this area is covered with tall mountain vegetation. Eleven groups were mapped in the west sub-zone. Most of them seem to pertain to humble domestic units organized in an informal and dispersed way. No groups were found with a PP2 format, nor palace-like structures. For the most part the settlement of this sub-zone could belong to the end of the Tepeu 2 phase, or it could be part of the Terminal Classic.

The central Manantiales sub-zone belongs to a corridor which extends itself directly to the south of the monumental epicenter. The topographic context pertains to a relatively narrow hill which borders to the east with a gorge; its associated vegetation is of mountain type. Twenty groups were mapped. The associated settlement consists of groups with "U" and "L" formats, similar to the ones described above for the east sub-zone of the Bajo La Pita, although they have more modest proportions ([Figure 9](#)). There were no plazas with PP2 format, although there are examples of plaza groups with low structures located at the corners. This sub-zone was likely occupied by administrative personnel, who worked in the monumental epicenter.

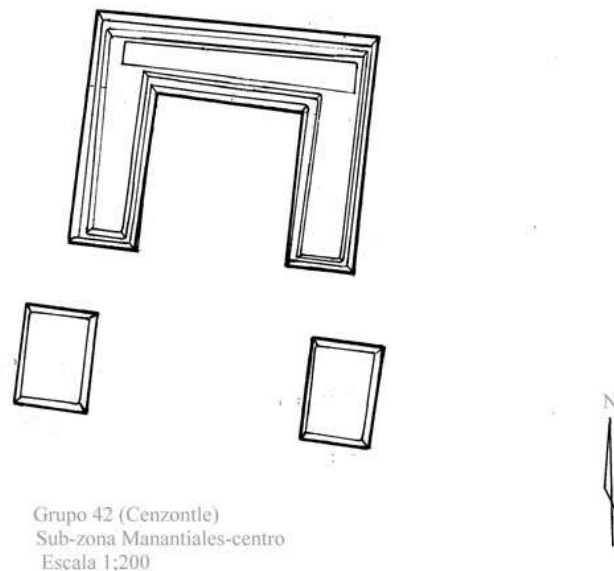

Figure 9. Plaza with "U" shaped structure.

The west Manantiales sub-zone is associated with a terrain of hillocks and hills of low altitude (less than 300 m asl). Eleven groups were mapped, characterized by including groups integrated with major palace-like units --four of them with an "L" format-- located in the south side of the plaza, which must have belonged to the

higher elite (Figure 10). Some palaces show a type of masonry with stone corners with moldings for water draining, as well as fragments of façade stones carved with decorative grooves. In the Manantiales zone one can see double-plaza arrangements, as well as groups of Plaza Plan 2 (Figure 10). This is the only sub-zone where we found a plaza arrangement integrated by pairs of palace-like buildings, whose function is yet to be established. Some looting activities performed in the mounds on the east side of the plazas have shown stratigraphies with several building stages, as seen in several superposed floors. Generally speaking the deepest floor is Tepeu 1, the intermediate floors (which are integrated to architecture with masonry of upright stones) are Tepeu 2, and the construction fills associated to the last stage near the top platform indicate building activities in the Tepeu 3 phase. Ceramic materials recovered from looted areas are helping us to define aspects of partial chronology.

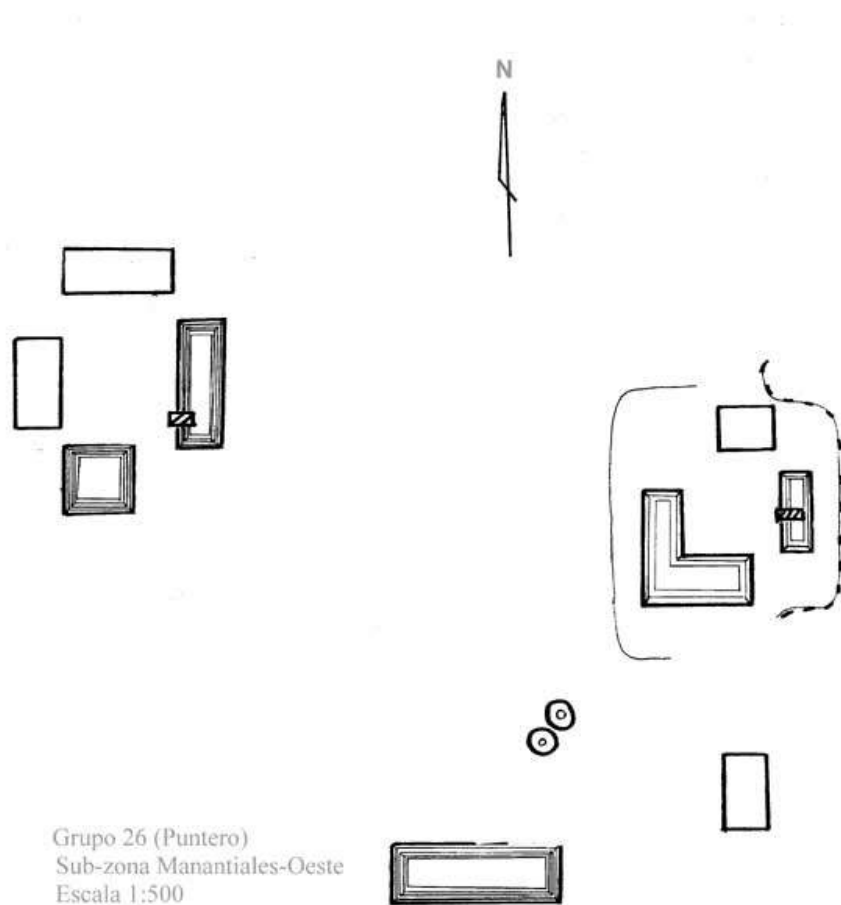

Figure 10. PP2 patio groups and "L" shaped platform.

The east Manantiales sub-zone pertains to a topographic environment of hills and terraces covered by mountain vegetation. This sub-zone is the least

explored, although preliminary surveys show that it was less densely occupied. At present only six groups have been explored, including 3-4 m high long platforms, which may have had an administrative function. The highest isolated sanctuary-temple associated with the periphery was found in this sub-zone. There were no PP2 arrangements. This zone is considered to have been linked to ritual or administrative activities.

Final Remarks

Naranjo's residential settlement density is considered to be higher in the areas with immediate water resources, that is in the south of the Bajo La Pita and the Manantiales area. Settlement density decreases gradually in the higher areas, as the west sub-zone of the Bajo La Pita and the east Manantiales sub-zone. There is a possibility that these zones with low occupation may have been areas for agricultural production. According to topographic evidence seen with the naked eye, some terraces might be found north of the Bajo.

An important aspect of Naranjo's southwest peripheral residential settlement was that only eight *chultunes* were found among a total of 93 recorded groups, which appeared in the sub-zones where water resources were restricted to the springs ([Figure 10](#)).

An important aspect to define the probable function and symbolism of "L" shaped buildings might be implied by the frequency with which these buildings seem to appear in the south end of the plazas ([Figure 6](#) and [Figure 10](#)), just like "U" shaped buildings seem to occupy the north end of the plazas ([Figure 8](#) and [Figure 9](#)). However, there are some exceptions where structures with a "U" format occupy other sectors of the plaza. Therefore, future research will allow us to know whether these buildings initially functioned with an "L" shape and later were transformed to a "U" format. Such a modification in a building's shape could have accompanied a change in the building's function, or else it could just mean that the occupying domestic group increased in size.

"L" and "U" shapes seem to coincide with palace-type buildings, which show greater dimensions and volume, probably indicating their relationship with elite residences, or public palace-like buildings where special production or administrative activities may have been carried out.

PP2 groups seem to have been more closely connected with commoner family groups, who were clustered in several patios ([Figure 6](#) and [Figure 10](#)). Palaces found in PP2 groups in the south sub-zone of Bajo La Pita may have had some administrative function or communal use for the surrounding residential groups. An interesting peculiarity seen in Naranjo's peripheral groups which include a PP2 format is that the sanctuaries usually show a rectangular base, which contrasts with what we know from other cities, where the base is usually square.

This was the first season of work in Naranjo's south periphery, therefore we are just starting to see some characteristics of a settlement pattern which may show in the future distinctive aspects of several converging settlement traditions. We expect to finish the survey of the southwest zone during the next season, as well as to finish the corresponding work in the southeast zone, in order to widen our conclusions on a comparative level.

Acknowledgments

The PIAREN project would like to express its acknowledgments to the Dirección General del Patrimonio Cultural y Natural (General Directorate of Cultural and Natural Heritage) for providing us with the operative personnel needed for carrying out the field activities. The Departamento de Monumentos Prehispánicos (Prehispanic Monuments Department) gave us logistical and technical support through its archaeologists. Famsi has supported us since 2005 with funds for logistics and recording. Harvard University's Peabody Museum has kindly donated resources for the conservation of Naranjo's sculptures, as well as for recording expenses. We also thank Takeshi Inomata for lending us his total station.

List of Figures

- [Figure 1.](#) Location of Naranjo archaeological site (Triangle and Belize map).
- [Figure 2.](#) Naranjo's natural environment (basins plan).
- [Figure 3.](#) Yaxhá-Naranjo transect.
- [Figure 4.](#) Map of quadrants of the southwest zone.
- [Figure 5.](#) Map indicating the sub-zones.
- [Figure 6.](#) PP2 patio group and "L" shaped platform.
- [Figure 7.](#) Informal plaza arrangement from the Terminal Classic period.
- [Figure 8.](#) Quadrangle with "U" shaped structure.
- [Figure 9.](#) Plaza with "U" shaped structure.
- [Figure 10.](#) PP2 patio groups and "L" shaped platform.

Sources Cited

Aquino, Daniel

2004 El Cuadrángulo A-19: Un conjunto arquitectónico restringido en el epicentro de Naranjo, Petén, en *XVIII Simposio de Investigaciones Arqueológicas en Guatemala*, pp. 243-252, Museo Nacional de Arqueología y Etnología, Guatemala.

Fialko, Vilma

1996 Sangre, sudor y lágrimas: Reporte monográfico de los sitios arqueológicos descubiertos, mapeados y muestreados en los espacios intersitios entre los centros urbanos mayas de Yaxhá y Naranjo, departamento de Petén, Guatemala. Primera Parte, Vol. II, y Segunda Parte, Vol. IV, en archivo, PRONAT-PROSIAPETEN, Instituto de Antropología e Historia de Guatemala.

2003 Investigaciones arqueológicas en la Acrópolis Triádica B-5 de Naranjo, en *XVII Simposio de Investigaciones Arqueológicas en Guatemala* (J.P. Laporte, B. Arroyo, H. Escobedo y H. Mejía, eds.), pp. 595-606, Museo Nacional de Arqueología y Etnología, Guatemala.

2004a Naranjo, Guatemala, en *Arqueología Mexicana*, Vol.XI, No. 66:56-57.

2004b Proceso evolutivo del epicentro urbano de Naranjo, Petén, en *XVIII Simposio de Investigaciones Arqueológicas en Guatemala*, pp. 253-268, Museo Nacional de Arqueología y Etnología, Guatemala.

2005 El palacio de la corte real de Naranjo, Petén, en *XIX Simposio de Investigaciones Arqueológicas en Guatemala*, Museo Nacional de Arqueología y Etnología, Guatemala.

Fialko, Vilma, Laura Gámez and José Crasborn

2002 Investigaciones arqueológicas y rescate en Naranjo. Temporada 2002, Reporte Monográfico en archivo PROSIAPETEN-PRONAT, Instituto de Antropología e Historia de Guatemala, Guatemala.

Fialko, Vilma, Laura Gámez and Daniel Aquino

2003 Investigaciones arqueológicas y rescate en Naranjo. Temporada 2003, Reporte Monográfico en archivo PROSIAPETEN-PRONAT, Instituto de Antropología e Historia de Guatemala, Guatemala.

2004 Investigaciones arqueológicas y rescate en Naranjo. Temporada 2004, Reporte Monográfico en archivo PROSIAPETEN-PRONAT, Instituto de Antropología e Historia de Guatemala, Guatemala.

Gámez, Laura L.

2003 El complejo de la pirámide de la escalinata jeroglífica de Naranjo, en *XVII Simposio de Investigaciones Arqueológicas en Guatemala* (J.P. Laporte, B. Arroyo, H. Escobedo y H. Mejía, eds.), pp. 587-594, Museo Nacional de Arqueología y Etnología, Guatemala.

Quintana, Oscar and Wolfgang Würster

2004 El plano del sitio maya de Naranjo, Petén, Guatemala, en *Beitrage zur Allgemeinen und Vergleichenden Archaologie*, Band 20, pp. 261-286, Mainz.

Appendix 1

MANANTIALES REGION, CENTRAL ZONE

Mano de León Group

(Code 22)

This group is located in the following coordinates: 16Q 0259856 y UTM 18 94854, on the south end of the path located to the south of the Naranjo camp. It is associated with a low hill with flat terrain on the top, and with a high and thick forest where the following trees are predominant: mano de león, cedrillo, zapotillo, ramón, cola de pava, chacaj, luin, sunsa macho, chicozapote, yaxnic, escobo, and botán.

This group includes eight structures distributed among three patios aligned on an east-west direction, adapted to moderate-sized terraces which served as natural foundations. Plaza 1 shows a Plaza Plan 2 format, while patio 2 shows an informal arrangement. Patio 3 is symmetrical, although it is integrated by just two structures.

Patio 1

This patio consists of four structures of rectangular base which make up a Plaza Plan 2-type compound. The East Sanctuary is of rectangular plan, and includes a looting in its north side. The looter's trench is 3 m long and on average 1 m wide. No material was collected.

The looter's trench of Structure 2 on the west side is 2 m long and 1.20 m wide; part of a substructure can be seen. Ceramic material was collected from the surface, including fragments of a possible censer and a bowl. The looter's trench in structure 3 in the south side is 2.75 m long and on average 1.2 m wide. The wall of a substructure can be seen, we collected ceramic surface material consisting of a possible censer and a bowl, which suggests that this was an elite structure.

Patio 2

Patio 2 is located to the east of Patio 1, is formed by three structures located on top of an artificial leveling like a foundation. The plaza's arrangement is asymmetrical, because the structures are not clearly aligned among themselves. The north side is occupied by a sanctuary with a square base, and in the southeast sector there is another square foundation (8). In the north sector of

structure 8 there is a looter's trench which on the west face shows a fill matrix of small limestone rocks and a lateral wall where we recovered a sample of ceramic material from the Late Classic.

The south sector of the patio is occupied by a long "L"-shaped platform. The plaza's west side and part of the east side were open.

Patio 3

Patio 3 is formed by structures 6 and 7, which define the north and east sides respectively.

<i>Mano de León</i>					
PATIO	STRUCTURE	LENGTH	WIDTH	HEIGHT	LOOTING
1	1	6.60	3.00	1.50	
	2	7.00	4.00	3.00	1 - facade west side
	3	9.20	5.00	2.00	1- south side
	4	8.00	4.00	2.00	1 - facade north side
2	5	4.80	5.00	3.00	
	6	12.00	5.00	2.00	L shape
	7	8.00	3.20	1.00	
	8	5.00	5.00	0.50	1 - facade east side

Cola de Pava Group
(Code 23)

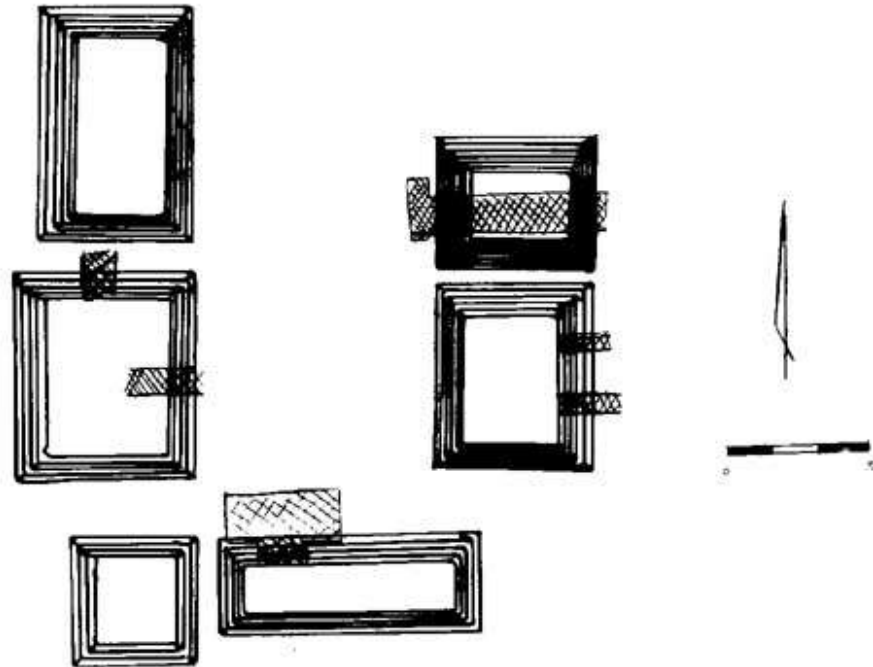

Naranjo, Petén
Periferia Oeste, Grupo 23
Zona Manantiales Sur-Centro
Escala 1;200

This group is located on the following coordinates: 16Q 0259773 and UTM 18 94683, on the south side of the path which is to the south of Naranjo's camp, associated with a moderate hill with flat terrain on the top. It is associated with a tall, dense forest where the following trees predominate: cola de pava, cedrillo, zapotillo, ramón, mano de león, chacaj, luin, sunsa macho, chicozapote, yaxnic, escobo, and botán.

This group follows a Plaza Plan 2 format, and includes six structures distributed around a single plaza which was open on the north sector. This compound apparently represents an elite residential settlement, and virtually all structures have a looter's trench.

In the east side is found a sanctuary (1), accompanied in the south sector by another quadrangular foundation. Both buildings were probably linked at the base by a banquette. The sanctuary was completely cut through by a tunnel-trench, which on the west façade has a great size in the form of a great pit of 4

by 5 m, then at the level of the first body the looting goes on for some 8.5 m long and on average 2.8 m wide. Bone material was collected in the building's back side, on the surface near the looter's trench. We saw that the floor of the second body was used twice; it is likely that the burial belongs to this level. The stratigraphic matrix was associated with grayish earth mixed with big and small limestone rocks.

The building (2) near the sanctuary shows two looter's trenches which destroyed the back side. The looting is 6 m long and on average 1 m wide; inside one can see two construction stages with their respective floors. There are indications of a crypt. One bag of ceramic material was collected. The second trench is 5 m long and on average 1 m wide; here one can see floors associated with three constructive periods of the Tepeu II phase. The fill matrix shows big limestone rocks.

In the south sector of the plaza we see a long structure (perhaps a palace) which on the west sector of the north façade shows looting consisting of a pit (4 x 2 m) and a trench (13 x 1 m). Here we see the remains of a substructure with masonry and a façade of well-cut ashlar stones, perhaps from the Tepeu II phase. In the profile one can see that the fill matrix of the building's final version includes small limestone rocks mixed with brown earth with lining from the Terminal Classic.

In the plaza's west sector there are two rectangular structures, the one located more toward the south (5) has a looter's trench (4 x 2.5 m) on the façade. One polychrome sherd was collected from the surface of the trench's fill. The fill matrix includes big limestone rocks. The structure (5) which is parallel to the former one may have had a "U" shape.

<i>Cola de Pava</i>					
PATIO	STRUCTURE	LENGTH	WIDTH	HEIGHT	LOOTING
1	1	8.50	7	6.00	1 crosses
	2	8.50	5.50	3.00	2 East-
	3	13	5.20	3.00	1 North
	4	6.50	6.50	2.00	
	5	10	9	3.00	1- North- East
	6	12	8.50	3.00	

Yaxnik Group
(Code 24)

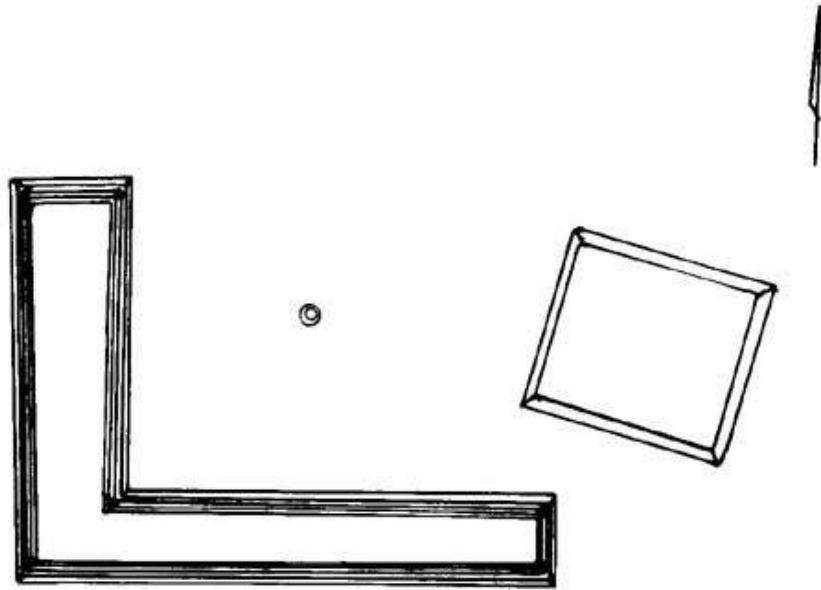

Naranjo, Petén
Periferia Oeste, Grupo 24
Zona Manantiales Sur-Centro
Escala 1:200

This group is located on the following coordinates: 16Q 02459680 and UTM 1894631, on the north side of the path which is to the south of Naranjo's camp, associated with a moderate hill with flat terrain on the top; it is associated with tall, dense forest in which the following trees predominate: yaxnic, cedrillo, zapotillo, ramón, mano de león, cola de pava, chacaj, luin, sunsa macho, chicozapote, escobo, and botán.

This group is located on a platform-like artificial leveling, and consists of two structures distributed around a single plaza which was open in the north sector. The compound apparently constitutes an elite residential settlement. In the southeast sector of the plaza there is a possible sanctuary which shows a looter's trench on the west façade (4 x 2 m) and a small tunnel of approximately 2 m. In the fill we see rough limestone blocks in the upper part and loose limestone rocks on the sides of the looter's cut. The construction may be from the Terminal Classic period, and may have functioned as a family sanctuary. At the foot of the mound near the looter's trench there are two sculpture fragments form part of a cornerstone with a molding in the perimeter and an incomplete hole near a corner. The second stone is a carved ashlar stone with vertical grooves. Both

carved stones seem to have been part of the façade of a major palace, perhaps from the monumental epicenter, which were taken to this place by inhabitants during the Terminal Classic period.

The plaza's western sector is occupied by an L-shaped structure, which is the dominant one in this compound.

<i>Yaxnik Group</i>					
PATIO	STRUCTURE	LENGTH	WIDTH	HEIGHT	LOOTING
1	1	22.00	16.20	3.50	
	2	8.00	7.80	0.80	1 West
	Chultun	0.60 cm. In diameter			

El Jobo Group
(Code 25)

This group is located in the following coordinates: 16Q 0259646 and UTM 18 94927, on the north side of the path that is found to the south of Naranjo's camp. It is linked with the low side of a moderate hill associated with a forest combining tall vegetation as well as bajo palms, among which the following predominate: jobo, cedrillo, zapotillo, ramón, mano de león, chacaj, escobo, aceituno, botán and palma de corozo.

This group is constituted by two structures distributed around a single plaza which was open in the north and west sectors. Apparently this compound represents an elite residential settlement. In the east sector there is a low sanctuary of square plan, located on a platform-like artificial leveling.

The patio's south side is defined by a palace-like structure which was preyed upon by cutting a 4.5 x 1.30 m trench through it. Inside the looted area we found at least three building stages which seem to belong to the Tepeu 2 and Tepeu 3 cultural phases, evidenced by their corresponding floors, which show a process of gradual growth. The masonry walls of the Tepeu 2 phase were built with well-placed upright limestone rocks. No material was collected.

<i>El Jobo</i>					
PATIO	STRUCTURE	LENGTH	WIDTH	HEIGHT	LOOTING
1	1	5.00	5.00	1.50	
	2	17.00	6.00	3.00	1- North

Puntero Group
(Code 26)

Naranjo, Petén
Periferia Oeste, Grupo 26
Zona Manantiales Sur-Centro
Escala 1;200

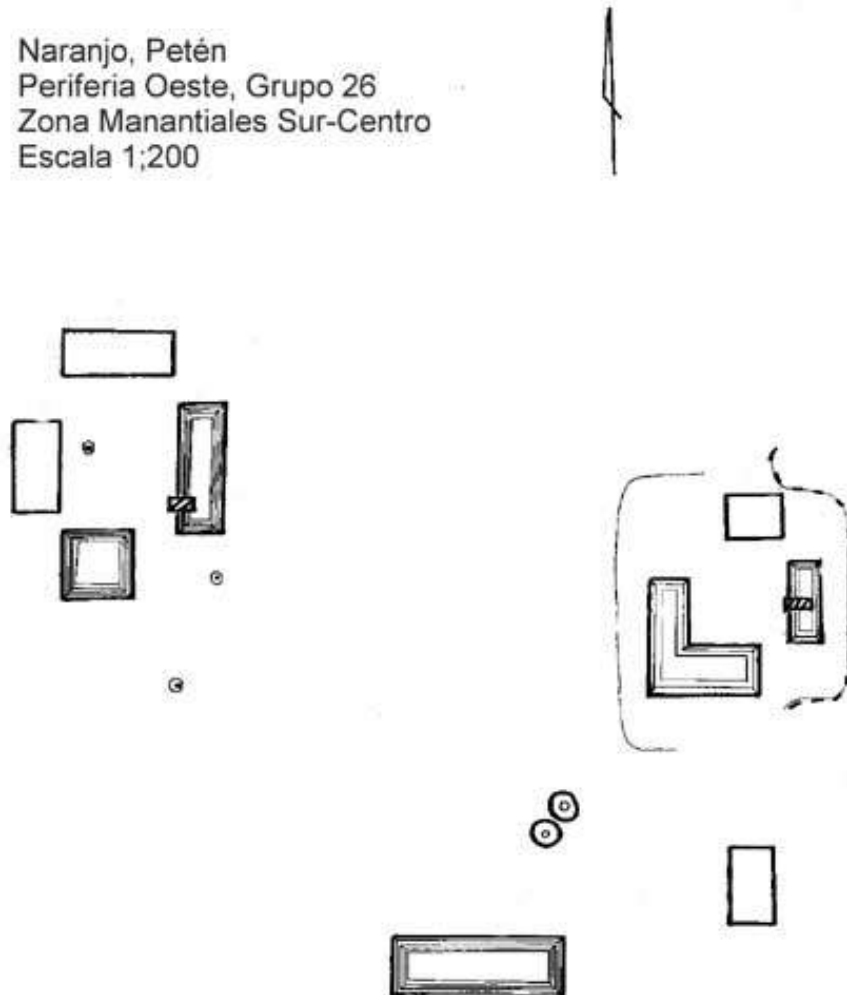

This group is found in the following coordinates: 16Q 0259572 and UTM 18 94816 to the north of the path found at the south of Naranjo's camp, over a natural elevation with flat terrain on the top. It is linked to tall and dense forest, in which the following trees predominate: puntero, cedrillo, zapotillo, ramón, chicozapote, yaxnic, white corozo, chillón, subin and copal.

This group is organized in three plazas, with a total of nine structures and two chultunes. Two of the plazas are of the Plaza Plan 2 type, and a third one – located a little more to the south – is of open type.

Patio 1

This patio is constituted by three structures, two of rectangular shape and one with L-shaped format. The structure on the east side has a looter's tunnel-trench on the west façade (4 x 1 m), showing the remains of a substructure with destroyed walls and a stucco floor. Small stones predominate in the fill matrix. Ceramic material was collected from the trench's surface. The plaza's south side is occupied by an L-shaped structure.

Patio 2

This patio is located over a natural leveling, at distance of approximately 21.70 m to the south of patio 1. Patio 2 includes two structures which may have been dwellings. Two chultunes of approximately 75 cm in diameter are located almost in the center of patio 2. No looting is seen in the structures of this patio.

Patio 3

This patio is located on a natural leveling at a distance of approximately 41.94 m to the west of patio 1, and has a Plaza Plan 2 format, integrated by four structures three of which have a rectangular plan and only the one on the south sector is of square base. In the structure on the east side is seen a looting on the west façade.

<i>Puntero</i>					
PATIO	STRUCTURE	LENGTH	WIDTH	HEIGHT	LOOTING
1	1	6	5	1.00	
	2	8.50	3.50	3.00	
	3	12.50	12	2.00	1- West
2	4	18	7	2.00	
	5	8	5	1.00	
	Chultún	0.75	0.75		
	Chultún	0.75	0.75		
3	6	14	5	3.00	1- West
	7	12	5	2.50	
	8	10	5	2.50	
	9	7.00	7.00	3.50	

Subin Group
(Code 27)

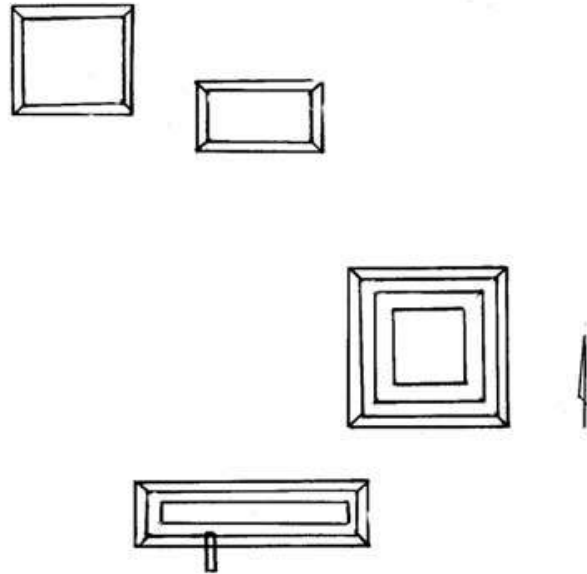

Naranjo, Petén
Periferia Oeste, Grupo 27
Zona Manantiales Sur-Centro

This group is found in the following coordinates: 16Q 0259507 and UTM 18 94547 to the south of the path found in the south of Naranjo's camp over a natural elevation with flat terrain on the top. It is linked to a tall, dense forest in which the following trees predominate: escobo negro, cedrillo, zapotillo, ramón, chicozapote, yaxnic, puntero, subin and escobo.

This group consists of a single L-shaped structure located on a natural, platform-like leveling. The looter's trench on the east side is 8.60 long by an average of .75 m wide. No substructure wall is seen. No archaeological material was collected. The looter's trench on the side of the west façade is 2.75 m long by 1.10 m wide, while the looter's trench on the façade on the north side is 4.40 m by 1 m. One can see a substructure wall in a bad state of preservation, with a brown-colored fill matrix with inclusions of big stones and mortar. No material was collected.

<i>Subin Group</i>					
PATIO	STRUCTURE	LENGTH	WIDTH	HEIGHT	LOOTING
1	1	6.80	4.00	0.50	
	2	6.60	6.00	0.50	
	3	8.80	5.60	3.00	
	4	12.60	4.60	2.50	1-South side

Escobo Negro Group
(Code 28)

This group is located on the following coordinates: 16Q 0259507 and UTM 18 94547, on the south of the path located on the south of Naranjo's camp, on a natural elevation with flat terrain on top. It is associated with a tall, dense forest in which the following trees predominate: *escobo negro*, *cedrillo*, *zapotillo*, *ramón*, *chcozapote*, *yaxnic*, *subin*, and *escobo*.

This group consists of a single, L-shaped structure located on an artificial, platform-like leveling. There is a looter's trench on the east side, measuring 8.60 m long by 0.75 m wide on average. No substructure wall is seen, and no archaeological material was collected. The looter's trench on the side of the west façade is 2.75 m long by 1.10 m wide. The looter's trench on the façade on the north side is 4.40 m x 1 m. A substructure wall is seen in a bad state of conservation. It has a fill with a brown-colored matrix including big rocks and mortar. No material was collected here.

<i>Escobo Negro Group</i>					
PATIO	STRUCTURE	LENGTH	WIDTH	HEIGHT	LOOTING
	1	18.00	17.50	4.00	1 East, 1 West 1 North

Cachucha
(Code 33)

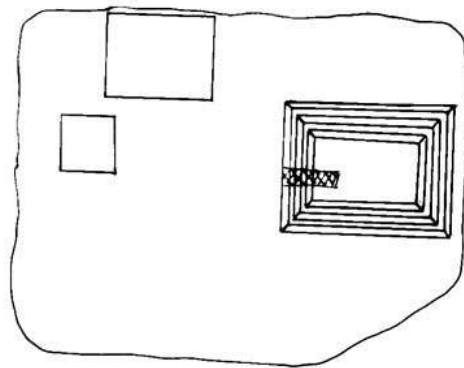

Naranjo, Petén
 Periferia Oeste, Grupo 33
 Zona Manantiales Sur-Centro
 Escala 1:200

This group is on the following coordinates: 16Q 0259560 and UTM 18 94943, on the south side of the path located on the south of Naranjo's camp, associated with a moderate hill with flat terrain on the top. It is associated with a forest where the following plants predominate: corozo and aunque palms, and palo de sunso.

Cachucha consists of a sunken plaza defined by three structures of rectangular shape, which left an open space on the south side. The distribution is asymmetrical, as the mound on the north side really occupies the sector on the northwest corner of the patio. The structure on the east side shows a looter's trench (4 m x 1 m) in the frontal façade, in which one can see walls. Fragments of a plate were collected from inside the structure.

<i>Cachucha Group</i>					
PATIO	STRUCTURE	LENGTH	WIDTH	HEIGHT	LOOTING
1	1	5.50	4.20	0.80	
	2	9.00	6.80	4.00	1 West
	3	3.00	3.00	0.50	

Aguila
(Code 35)

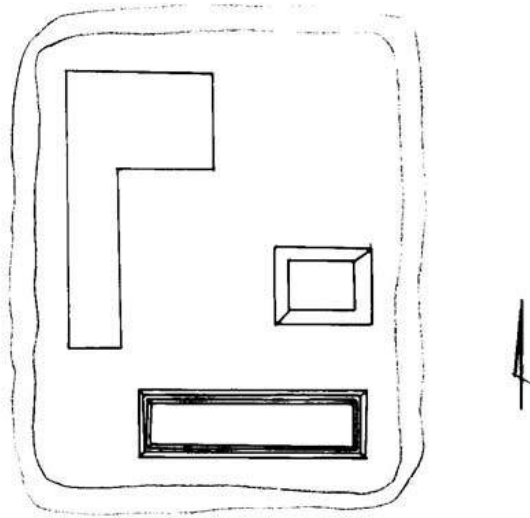

Naranjo, Petén
 Periferia Oeste, Grupo 35
 Zona Manantiales Sur-Centro
 Escala 1:200

Aguilá is found in the following coordinates: 16Q 0259595 and UTM 18 94930, on the south side of the path found to the south of Naranjo's camp, linked to a moderate hill with flat terrain on the top. It is associated with tall, dense forest, in which corozo palms and some sunso trees predominate.

Aguilá consists of a plaza defined by three structures showing an asymmetrical arrangement. The structure on the east side could pertain to a sanctuary, while the one on the south is a rectangular platform that could have had several transversal precincts. The plaza's west and north sides are defined by a long L-shaped structure. No lootings are seen.

<i>Aguilá Group</i>					
PATIO	STRUCTURE	LENGTH	WIDTH	HEIGHT	LOOTING
1	1	L=13.40/7.00	3.50	0.50	
	2	4.80	4.00	1.00	
	3	11.00	4.00	2.50	

Yaya Group
(Code 36)

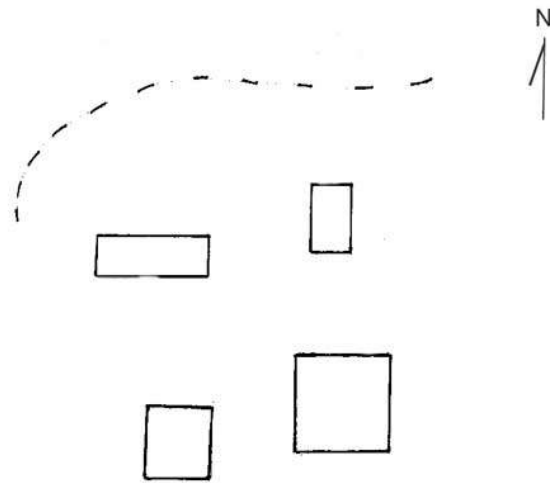

Naranjo, Petén
 Periferia Oeste, Grupo 36
 Zona Manantiales Sur-Centro
 Escala 1;200

This group is located on the following coordinates: 16 Q0259887 and 1895595 UTM, on the east side of the path leading to the water springs (Manantiales) adjacent to IDAEH's camp in Naranjo, on a natural elevation with flat terrain on the top. It is associated with tall, dense forest, in which the following trees predominate: ramón, subin, indio desnudo, yaya, and mano de león.

This group consists in a plaza made up of four structures organized in an asymmetrical fashion. On the east side it is delimited by two structures, one of which has a square base and may have pertained to a sanctuary. Toward the north there is another structure of rectangular plant and smaller proportions. The west side is also occupied by two structures, a square one which faces a similar one on the east side on the east side, and a rectangular one more to the north. The plaza's north and south sides were left open. No looting is seen here.

<i>Yaya Group</i>					
PATIO	STRUCTURE	LENGTH	WIDTH	HEIGHT	LOOTING
1	1	3.40	3.00	1.00	
	4	6.00	3.00	1.00	
	3	3.80	3.40	1.00	
	2	5.20	5.00	1.00	

**Ceibillo Group
(Code 37)**

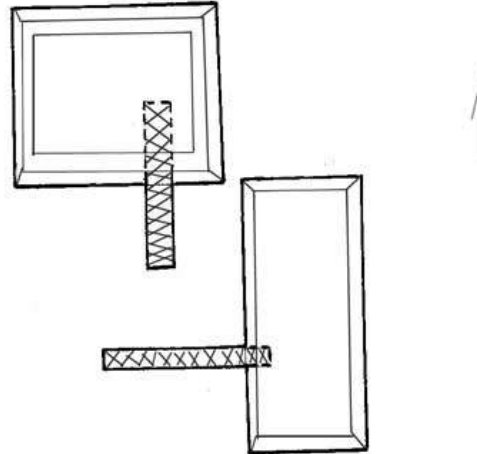

Naranjo, Petén
Periferia Oeste, Grupo 37
Zona Manantiales Sur-Centro
Escala 1:200

This group is located on the following coordinates: 16 Q0259614 and 1895198 UTM, to the east of the path leading to the springs adjacent to IDAEH's camp in Naranjo, on a natural elevation with flat terrain on the top. It is associated with tall, dense forest, in which the following trees predominate: ramón, subin, indio desnudo, yaya, and mano de león.

This group consists of a plaza integrated by two structures of rectangular shape, located on an artificial, platform-like elevation. The north structure has a looter's trench on the south side (4.90 m x 1 m). It shows a wall and a fill of big limestone rocks; ceramic material was collected. The structure on the east side also shows looting on the façade (5.80 m x .83 m). A substructure wall was seen, with a fill of small and big stones. The south and west sides of the plaza are open.

<i>Ceibillo</i>					
PATIO	STRUCTURE	LENGTH	WIDTH	HEIGHT	LOOTING
1	1	9.60	8.60	1.50	1 South
	2	13.00	5.60	1.00	1- West

Jocote Group
(Code 38)

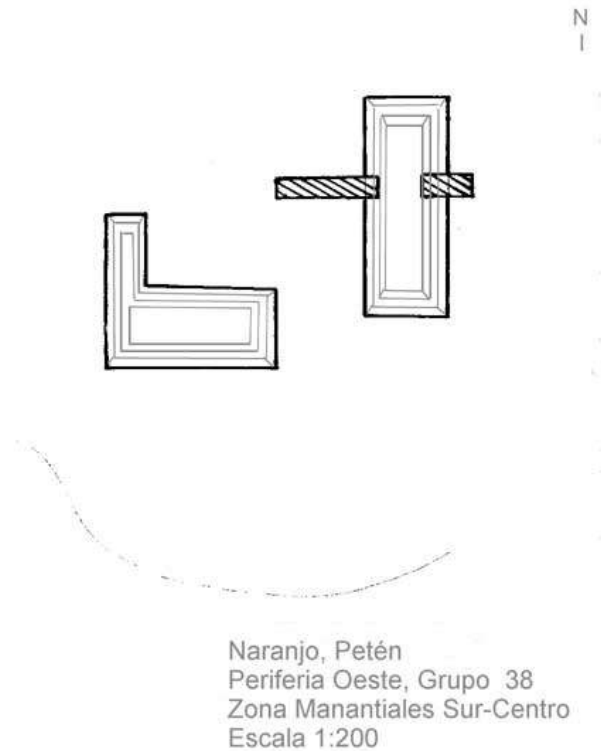

This group is located in the following coordinates: 16 Q259614 and 1895198 UTM on a natural elevation to the north of the road that leads to IDAEH's camp in the zone of major ruins or epicenter of Naranjo. It is associated with a tall, dense forest, where the following trees predominate: botán, chacaj, chicozapote, sumso, amate, escobo, ixcanal, laurel, ramón, subin, indio desnudo, yaya, and mano de león.

This group consists of a plaza integrated by two structures. The east side is occupied by a rectangular structure showing two looter's trenches, one on the front (7.80 m x 1 m) showing a fill of big stones with a gray matrix, from which ceramic material was collected. The other trench is located on the back side (2.50 m x 0.90 m), where we saw the wall of a substructure with a fill of big stones and a gray matrix. The south and west sides of the plaza are defined by a structure with an "L" format, whose longest segment is in the south sector.

<i>Jocote Group</i>					
PATIO	STRUCTURE	LENGTH	WIDTH	HEIGHT	LOOTING

1	1	10.20	4.00	2.00	2 – façade West and East
	2	L= 8.00/7.00	4.00	2.00	

Palo de Guaya Group
(Code 39)

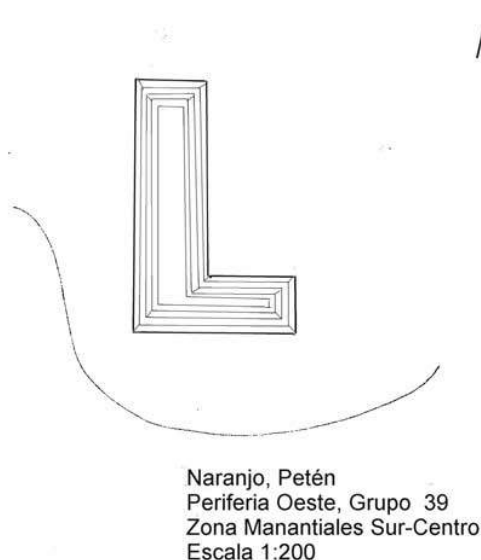

This group is located on the following coordinates: 16 Q259650 and 18951147 UTM on a natural elevation to the north of the road leading from IDAEH's camp to the zone of major ruins, or Naranjo's epicenter. It is associated with a tall, dense forest in which the following trees predominate: botán, chacaj, chicozapote, sumso, amate, escobo, ixcanal, laurel, ramón, subin, indio desnudo, yaya, and mano de león.

The plaza is integrated by only one tall, L-shaped structure whose long segment defines the west side and the short one is in the south sector. There is a looting in the east side façade.

<i>Palo de Guaya</i>					
PATIO	STRUCTURE	LENGTH	WIDTH	HEIGHT	LOOTING
	1	14.20	4.50	2.50	1 East

Chilar Group
(Code 40)

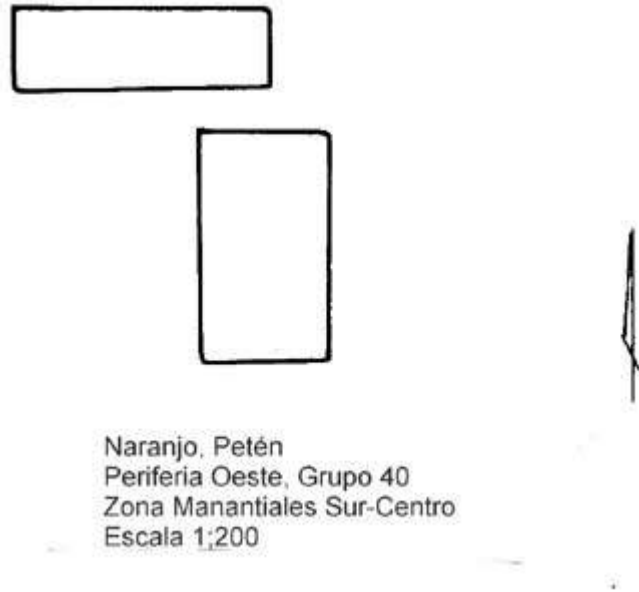

This group is found on the following coordinates: 16 Q259778 and 1894973 UTM to the north of the road leading from IDAEH's camp to the zone of major ruins or epicenter of Naranjo. It is associated with a tall, dense forest in which the following trees predominate: botán, chacaj, chicozapote, sumso, amate, escobo, ixcanal, laurel, ramón, subin, indio desnudo, yaya, and mano de león.

The plaza is located on a small natural elevation, and is integrated by two rectangular structures which define the north and east sides. No looting was recorded here.

<i>Chilar</i>					
PATIO	STRUCTURE	LENGTH	WIDTH	HEIGHT	LOOTING
1	1	8.60	4.00	1.00	
	2	8.00	4.60	1.00	

Colibrí Group
(Code 43)

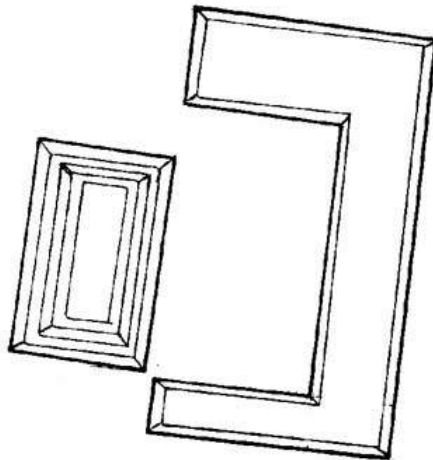

Naranjo, Petén
 Periferia Oeste, Grupo 43
 Zona Manantiales Sur-Centro
 Escala 1;200



This group is found in the following coordinates: 16 Q259484 and 1895197 UTM, on a natural elevation to the north of the road leading from IDAEH's camp to the zone of major ruins or epicenter of Naranjo. It is associated with a tall and dense primary forest, in which the following trees predominate: botán, chacaj, chicozapote, sumso, amate, escobo, ixcanal, laurel, ramón, subin, indio desnudo, yaya, and mano de león.

The plaza is located on a platform-like artificial leveling which is integrated by two structures. The east, north and south sides are occupied by a structure with "U" format, while the west side is occupied by a high structure with rectangular plan. No looting is seen here.

<i>Colibrí Group</i>					
PATIO	STRUCTURE	LENGTH	WIDTH	HEIGHT	LOOTING
1	1	U= 20.40	2 segmt =11.80	1.00	
	2	10.20	6.60	3.00	

Mariposa Group
(Code 45)



Naranjo, Petén
Periferia Oeste, Grupo 45
Zona Manantiales Sur-Centro
Escala 1;200

This group is located on the following coordinates: 16 Q0259887 and 1895595 UTM, on the south side of the road leading to the springs adjacent to IDAEH's camp in Naranjo, on a natural elevation with flat terrain on the top. It is associated with high, dense forest in which the following trees predominate: ramón, subin, indio desnudo, yaya, and mano de león.

This group consists of a plaza integrated by a single mound with rectangular plan, which shows an orientation slanted to the northeast. It probably pertains to the Terminal Classic period. No lootings are seen here.

<i>Mariposa Group</i>					
PATIO	STRUCTURE	LENGTH	WIDTH	HEIGHT	LOOTING
1	1	3.40	3.00	1.00	

Appendix 2

MANANTIALES REGION, WESTERN ZONE

Cedrillo Group
(Code 05)

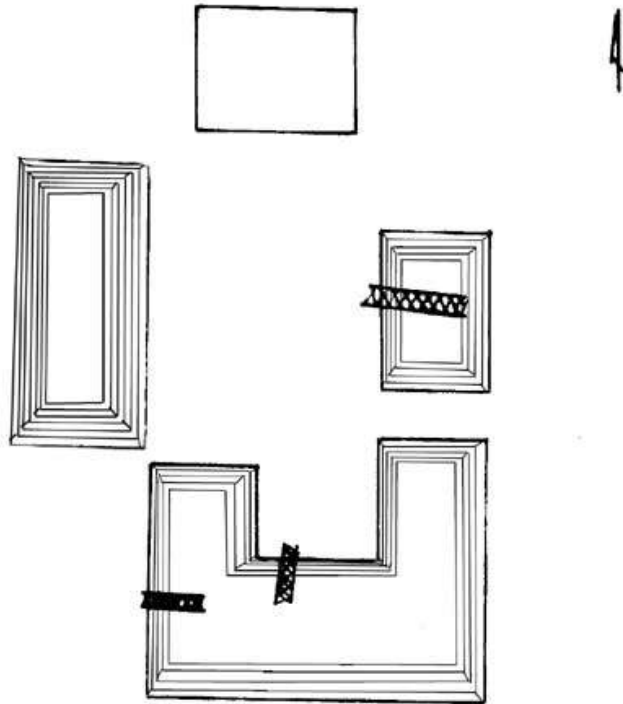

Naranjo, Petén
Periferia SW-Grupo 05
Zona Manantiales Oeste
Escala 1:200

This group is located on the following coordinates: 16 Q0259334 and 1895010 UTM, on the west side of the path leading to IDAEH's camp in Naranjo, on a natural elevation with flat terrain at the top. It is associated with a tall, dense forest in which the following trees predominate: ramón, cedrillo, subín, puntero, zapotillo, palo de agua, pimienta, matapalo, cedro, chicozapote, jobo, cedrillo blanco, laurel, palmas de escobo, botán, and corozo.

This group consists of a plaza integrated by four structures organized in a symmetrical way. Its function seems to have been residential and administrative. On the north side is found a rectangular platform, possibly of domestic function.

The patio's east sector is occupied by a sanctuary showing a looter's tunnel in the axis of the main façade. To the south is a palace with a "U" format and two parts oriented to the north. Looter's tunnels are seen in the north façade and in the façade on the west side. The plaza's west sector is occupied by another palace of greater height.

Cedrillo Group					
PATIO	STRUCTURE	LENGTH	WIDTH	HEIGHT	LOOTING
1	1	6.60	5.20	0.50	
	2	6.60	4.40	2.50	1 W
	3 "U"	14.00	6.00 Seg.E=5m Seg.W=4m	3.50	1N; 1W
	4	12.0	4.60	4.00	

Las Raíces Group
(Code 08)

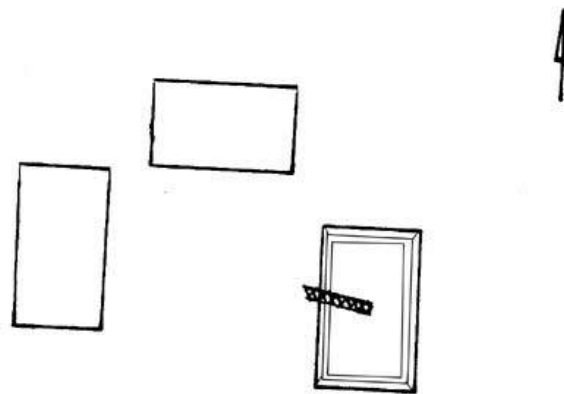

Naranjo, Petén
Periferia SW-Grupo 08
Zona Manantiales Oeste
Escala 1:200

This group is located on the following coordinates: 16 Q0259431 and 1894436 UTM, on the west side of the path leading to IDAEH's camp in Naranjo, on a natural elevation with flat terrain on the top. It is associated with a dense forest, in which the following trees predominate: *ramón, cedrillo, subín, puntero, zapotillo, palo de agua, pimienta, matapalo, cedro, chicozapote, jobo, cedrillo blanco, laurel, palmas de escobo, botán, and corozo.*

This group consists of a plaza integrated by three structures organized in a symmetrical fashion, which leaves an open space on the south side. Its function seems to have been of a domestic nature. On the north side there is a low rectangular platform. The east sector is occupied by a sanctuary of rectangular base, showing a looter's tunnel on the front side. The west side is defined by another domestic platform of rectangular plan.

<i>Las Raíces Group</i>					
PATIO	STRUCTURE	LENGTH	WIDTH	HEIGHT	LOOTING
1	1	6.60	4.20	0.50	
	2	7.60	4.60	1.50	
	3	7.60	4.20	0.50	

Pirata Group
(Code 11)

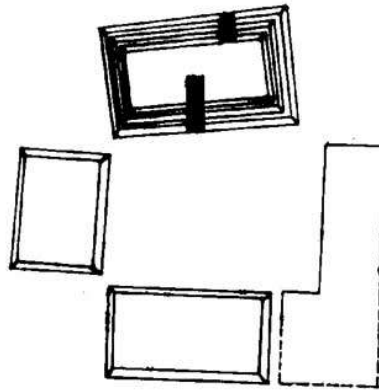

Naranjo, Petén
Periferia Oeste, Grupo 11.
Zona Manantiales Oeste
Escala 1;200

This group is located in the following coordinates: 16 Q0259385 and 1894603 UTM, on the west side of the path leading to IDAEH's camp in Naranjo, on a natural elevation with flat terrain on top, at 257 m above sea level (asl). It is associated with a tall and dense forest, in which the following trees predominate: *ramón, cedrillo, subín, puntero, zapotillo, palo de agua, pimienta, matapalo, cedro, chicozapote, jobo, cedrillo blanco, laurel, palmas de escobo, botán, and corozo.*

This group consists of a plaza integrated by four structures organized in a symmetrical way on a relatively sunken foundation. In the north side is the building of greatest dimensions, with pyramidal base measuring over 3 m in height. It has two looter's tunnels, the one on the front shows an E-W wall and three floors with small stones and mortar. One can also see big ashlar stones, and tunnels branching out toward the sides. The looting in the back side shows a room. The plaza's east side is delimited by an L-shaped structure, with the appendix toward the west in the south end, which forms a small alley with the rectangular structure which defines the plaza's south side. One of them is of square base, the west side is occupied by a rectangular foundation which seems to be a residential structure. No pottery was collected here.

<i>Pirata Group</i>					
PATIO	STRUCTURE	LENGTH	WIDTH	HEIGHT	LOOTING
1	1	3.40	3.00	1.00	
	4	6.00	3.00	1.00	
	3	3.80	3.40	1.00	
	2	5.20	5.00	1.00	

Pié del Cerro Group
(Code 15)

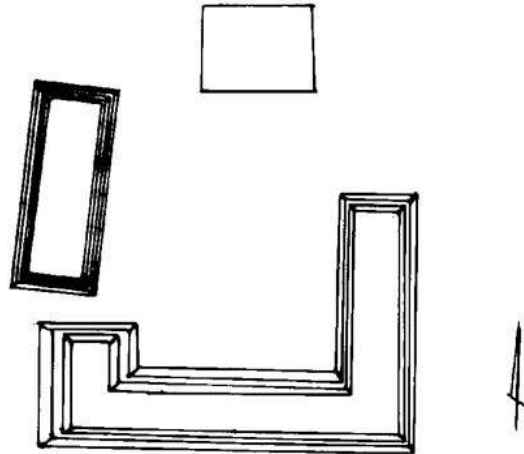

Naranjo, Petén
Periferia Oeste, Grupo 15
Zona Manantiales Oeste
Escala 1;200

This group is found on the following coordinates: 16 Q0259345 and 1894993 UTM, to the west of the road leading to IDAEH's camp at a height of 220 m asl, it is associated with a spur near the foot of a hill. There are two additional groups of structures at the top of the hill. The associated vegetation consists of *ramón*, *zapotillo*, *malerio*, *cedro*, *sunso*, *cedrillo*, *jobo*, *copal*, and *cola de pava*, also seen are several *palmas de botán*, *corozo* and *escobo*.

This group was adapted to a sunken sector, which gives it an almost closed shape. It follows a plaza format, integrated by three structures, the one in the south has an incomplete "U" shape, which is a prototypical feature of Naranjo's periphery. The north side is defined by a low rectangular structure of obvious domestic function. In the south side there is a U-shaped structure of large size, whose eastern wing occupies a good part of this sector of the plaza. To the west we see a rectangular structure which could pertain to a small vaulted palace. A sector of the southwest side of the plaza is occupied by a wing of the U-shaped building.

No samples of archaeological materials were collected from any of the lootings.

<i>Pie del Cerro</i>					
PATIO	STRUCTURE	LENGTH	WIDTH	HEIGHT	LOOTING
1	1	6.00	4.50		
	2	19.50 (13.50E) (6.60W)	4.50		
	3	11.00	4.50		

Mayor del Cerro Group
(Code 16)

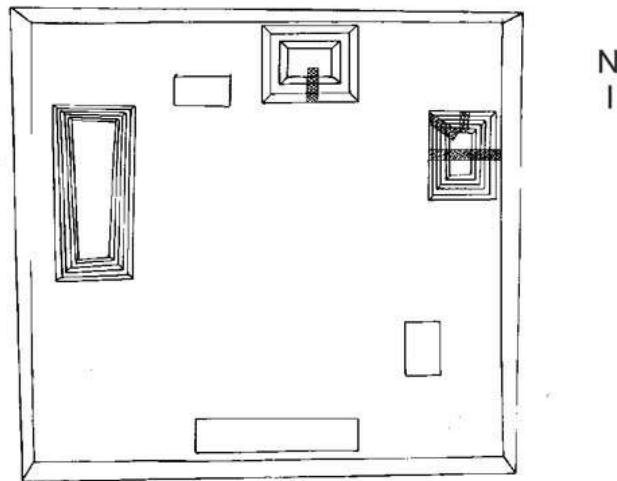

Naranjo, Petén
Periferia Oeste, Grupo 16
Zona Manantiales Oeste
Escala 1;400

This group is located on the following coordinates: 16 Q0259190 and 1894998 UTM, on the west side of the road leading to IDAEH's camp, at a height of 309 m asl. It is associated with a hill covered by a tall, dense forest, in which the following trees predominate: *ramón, cedrillo, chacaj, puntero, zapotillo, malerio, guaya, jobo, copal, subin, pimienta, cilión* and *ceibillo*.

A plaza was adapted over a leveled area, integrated by six structures organized in a symmetrical fashion, which originally might have been a Plaza Plan 2 format. The north side is defined by a rectangular temple organized in two bodies, which shows a looter's trench in the south façade. Adjacent to the west side there is a

low platform apparently of domestic nature organized in three bodies; this building was severely preyed upon by a tunnel which goes across it completely from east to west. The building also shows two deep looter's trenches, one in the NW corner and another one on the north façade. Some 12 m to the south there is a low rectangular platform, which may have been of domestic nature or of service to the temple. The plaza's south side is occupied by a long, narrow foundation which may also have been residential. The compound's major building sits on the plaza's west side, and seems to pertain to a palace which shared a axis with the pyramid on the east side. It shows two looter's trenches on the back façade which allow one to see the collapsed walls. No pottery was collected.

<i>Mayor del Cerro Group</i>					
PATIO	STRUCTURE	LENGTH	WIDTH	HEIGHT	LOOTING
1	1	5.40	3.00		
	2	10.40	8.00		
	3	9.00	6.80		
	4	5.20	3.80		
	5	16.00	4.00		
	6	17.40	8.00		

Menor del Cerro Group
(Code 17)

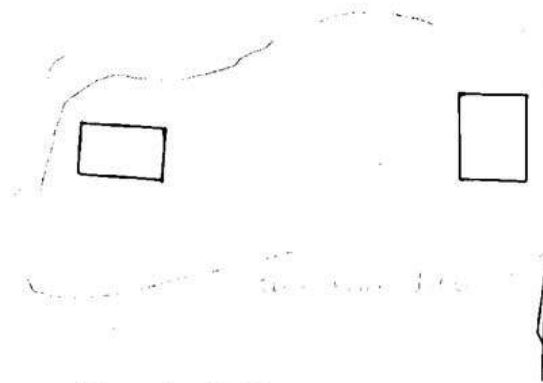

Naranjo, Petén
 Periferia Oeste, Grupo 17
 Zona Manantiales Oeste
 Escala 1;200

This group is located on the following coordinates: 16 Q0259222 and 1894926 UTM in the spur of a hill located to the west of the camp, at an approximate altitude of 279 m asl. One can see vegetation including the following trees: *ramón, cedrillo, jobo, chicozapote, matapalo, zapotillo, subín, cedro*, and some *escobo* and *botán* palms.

This group follows an open plaza format on the north and south ends. The patio's east sector is occupied by a low rectangular structure with an elongated north-south axis, which shows two looter's trenches: one on the façade and one on the back side. The patio's west sector is occupied by another low foundation of rectangular plan with an elongated east-west axis. No samples of archaeological materials were collected. There are no lootings.

<i>Menor del Cerro</i>					
PATIO	STRUCTURE	LENGTH	WIDTH	HEIGHT	LOOTING
1	1	4.20	3.20		
	2	4.00	2.5.0		

los Zopes Group
(Code 18)

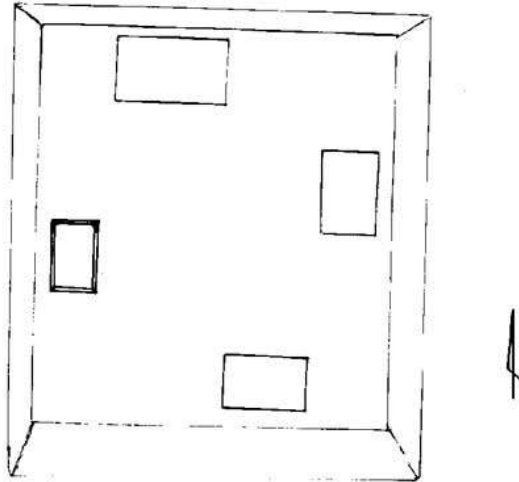

Naranjo, Petén
Periferia Oeste, Grupo 18
Zona Manantiales Oeste
Escala 1:200

This group is located on the following coordinates: 16 Q0259356 and 1894916 UTM, on the west side of the path leading to IDAEH's camp in Naranjo, at a height of 222 m asl. It is located on a slight natural elevation with flat terrain on the top, which appears to have been adapted to serve as the group's foundation. The environment includes a mixed vegetation of short and tall forest, since the following species are intermingled: *corozo*, *botán* and *escobo* palms, as well as tall and dense forest species, in which the following trees predominate: *ramón*, *copal*, *jobo*, *cedrillo blanco*, *jesmo*, *yaxnic*, *cilión*, *sunso*, *maleiro*, *puntero*, *zapotillo*, and *matapalo*.

This group consists of a plaza of possible Plaza Plan 2 format, which is integrated by four low structures organized in a symmetrical fashion. The east side is delimited by a platform of quadrangular base, which may have functioned as a low sanctuary. To the north one can see another platform of rectangular plan, although this one covers a larger area. The west side is defined by a structure which, although of greater height than the others, also appears to have

been of a merely domestic nature. On the patio's south side is found the fourth platform, a little shifted to the east sector. There are no lootings.

<i>Los Zopes Group</i>					
PATIO	STRUCTURE	LENGTH	WIDTH	HEIGHT	LOOTING
1	1	5.80	3.20		
	2	4.20	2.80		
	3	4.20	2.60		
	4	3.60	2.50		

Solitario Group
(Code 29)

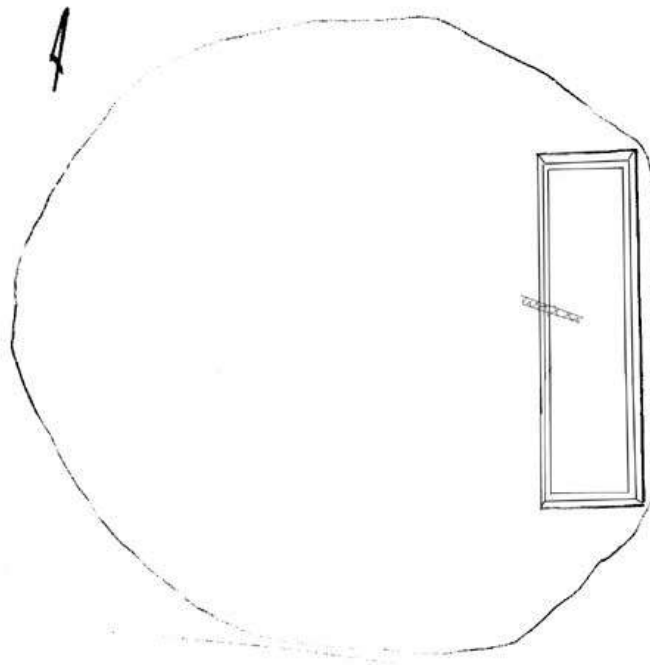

Naranjo, Petén
Periferia SW-Grupo 29
Zona Manantiales Oeste
Escala 1:200

This group is located on the following coordinates: 16Q 0259507 and UTM 18 94547, to the north of the path which is on the south of Naranjo's camp, on a natural elevation with flat terrain on the top. It is associated with a tall, dense

forest in which the following trees predominate: *cedrillo*, *zapotillo*, *ramón*, *chicozapote*, *yaxnic*, *subin*, and *escobo*.

This group is integrated by a single rectangular structure oriented east-west. There are no looting.

Solitario					
PATIO	STRUCTURE	LENGTH	WIDTH	HEIGHT	LOOTING
	1	20.00	10.60	1.50	

Amarillin
(Code 30)

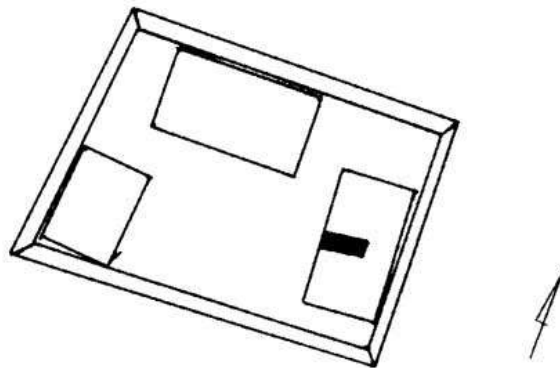

Naranjo, Petén
Periferia Oeste, Grupo 30
Zona Manantiales Oeste
Escala 1:200

Amarillin is located on the following coordinates: 16Q 0259411 and UTM 18 94547, on the south side of the path which is on the south of Naranjo's camp, it is associated with a slight hill with flat terrain on the top. It is associated with a forest of *corozo* and *escobo* palms, as well as some *sunso* trees.

This group is organized on a platform, it consists of a single plaza defined by three structures of rectangular shape, which leave an open space on the south side. The layout is asymmetrical, since the mound on the west side really occupies the sector of the patio's southwest corner. The structure on the east side shows a looter's trench (3 m x 1 m) on the front façade. In the sector of this

predator's pit we found two fragments of flint projectile point. The fill in the trench's cut is made of minute limestone rocks.

<i>Amarillin Group</i>					
PATIO	STRUCTURE	LENGTH	WIDTH	HEIGHT	LOOTING
1	1	7.50	4.50	0.60	
	2	7.00	4.50	0.90	1 West
	3	5.00	3.80	0.70	

Cedrillo Blanco
(Code 32)

Cedrillo Blanco is located on the following coordinates: 16Q 0259115 and UTM 18 94635, on the south side of the path which is found on the south of Naranjo's camp. It is associated with a slight hill with flat terrain on the top. It is associated with tall, dense forest, in which the following trees predominate: *cedrillo blanco*, *zapotillo*, *puntero*, *ramón*, *sunso*, *yaxnic*, *palo de danto*, *laurel*, and *corozo*, *escobo*, and *botán* palms.

Cedrillo Blanco consists of a low plaza defined by three structures of rectangular shape, leaving an open space on the north side. The layout is asymmetrical, since the structure on the south side actually sits on the sector of the southeast corner of the patio. No lootings were seen here.

<i>Cedrillo Blanco Group</i>					
PATIO	STRUCTURE	LENGTH	WIDTH	HEIGHT	LOOTING
1	1	5.20	3.50	0.50	
	2	11.60	4.00	1.30	
	3	4.40	3.50	0.40	

El Banano
(Code 34)

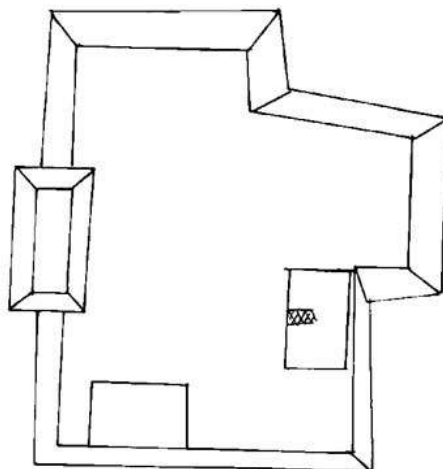

Naranjo, Petén
Periferia Oeste, Grupo 34
Zona Manantiales Oeste
Escala 1;200

El Banano is found on the following coordinates: 16Q 0259376 and UTM 18 94799, on the south side of the path at the south of Naranjo's camp. It is associated with a hill with flat terrain on the top, and with a tall, dense forest in which the following trees predominate: *cedrillo*, *zapotillo*, *ramón*, *copal*, *jobo*, *pimienta*, *chacaj*, *maleiro*, *luin*, and *corozo* palms.

El Banano consists of a plaza organized on an elevated platform, with three structures of rectangular shape, leaving an open space on the north side. The structure on the east side shows a looting on the front façade of approximately 2.50 x 1 m.

<i>El Banano Group</i>					
PATIO	STRUCTURE	LENGTH	WIDTH	HEIGHT	LOOTING
1	1	5.40	3.50	0.40	1 West
	2	5.00	3.20	0.30	
	3	7.60	4.00	1.30	

Appendix 3

MANANTIALES REGION, EAST ZONE

Confite Group
(Code 46)

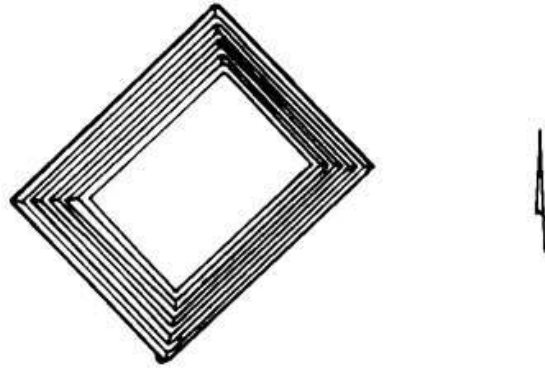

Naranjo, Petén
Periferia. Grupo 46
Zona Manantiales Este
Escala 1:200

This group is located on the following coordinates: 16 Q0259120 and 1894519 UTM, near Naranjo's entrance archway, to the south of the road leading to IDAEH's camp, toward Melchor de Mencos, on a small hill near a gorge. It is associated with a tall forest, in which the following trees predominate: *cedro*, *ramón*, *jobo*, *copal*, *zapotillo*, *cojón*, *corozo*, *yaxnic*, *caulote*, and *chicozapote*.

This group consists of a plaza integrated by a single pyramidal structure which may have functioned as a sanctuary. No lootings are seen here.

<i>Confite Group</i>					
PATIO	STRUCTURE	LENGTH	WIDTH	HEIGHT	LOOTING
1	1	11.20	9.80	5.00	

Verde Group
(Code 47)

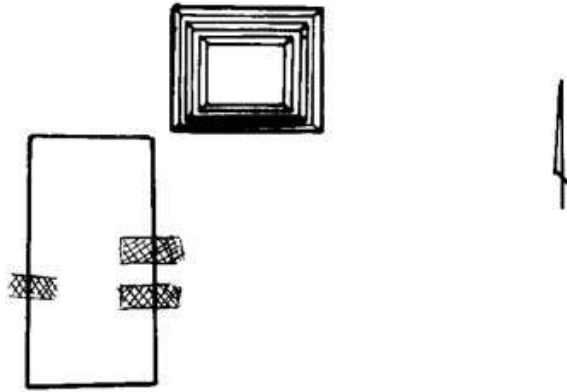

Naranjo, Petén
Periferia. Grupo 47
Zona Manantiales Este
Escala 1:200

This group is located on the following coordinates: 16 Q0259887 and 1895595 UTM, near the El Limón water springs, to the south of the road leading to IDAEH's camp in Naranjo, toward Melchor de Mencos, on the slopes of a small hill. It is associated with a tall forest, in which the following trees predominate: *ramón*, *valerio*, *cedrillo*, *copal*, *ceiba*, *aceituna*, *jesmo*, *cilión*, and *palma de guano*.

The plaza is integrated by just two rectangular structures which delimit the north and west sectors of the patio. The west building was affected by three looter's trenches, two on the frontal façade (4 x 1.30 m and 3.50 x 1 m) and one on the back side (3 x 1 m). No potsherds were collected.

<i>Verde Group</i>					
PATIO	STRUCTURE	LENGTH	WIDTH	HEIGHT	LOOTING
1	1	6.00	4.50	3.00	
	2	10.00	5.00	0.70	2 Este 1 Oeste

Azul Group
(Code 49)

This group is located near the El Limón water springs, to the south of the road leading to IDAEH's camp in Naranjo, toward Melchor de Mencos, on the slopes of a small hill. It is associated with a tall forest in which the following trees predominate: *ramón, pimienta, guaya, jobo, sunzo, zapotillo, cedrillo, copal, and yaxnic.*

The plaza is open to the south, the other three sides are delimited by three long structures which appear to have been palaces, probably with transversal precincts. Their function may have been residential or perhaps administrative. A looting is seen (4 x 1.40 m) in the structure on the east side, on the front façade.

<i>Verde Group (monkeys)</i>					
PATIO	STRUCTURE	LENGTH	WIDTH	HEIGHT	LOOTING
1	1	17.00	5.80	4.00	
	2	12.80	6.00	1.50	1 West
	3	11.00	4.20	4.00	

Gris Group
(Code 50)

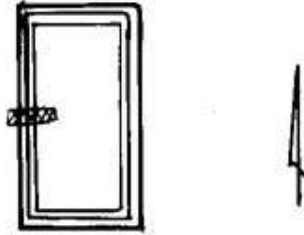

Naranjo, Petén
Periferia. Grupo 50
Zona Manantiales Este
Escala 1:200

This group is located in the area of the El Limón water spring, to the south of the road leading to IDAEH's camp in Naranjo, toward Melchor de Mencos. It is associated with a tall forest, in which the following trees predominate: *chicozapote*, *guaya*, *pimienta*, *matapalo*, *sunzo*, *valerio*, *cedrillo*, *mano de león*, *copal*, and *botán*.

The plaza is located on a hill, and is integrated by a single rectangular structure oriented on a north-south direction. It has a looter's trench on the west façade.

Rojo Group
(Code 51)

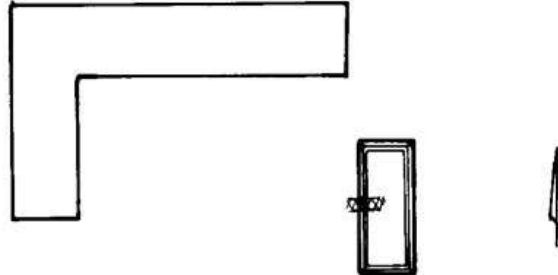

Naranjo, Petén
 Periferia. Grupo 51
 Zona Manantiales Este
 Escala 1:200

This group is located in the area of the El Limón water spring, to the south of the road leading to IDAEH's camp in Naranjo, toward Melchor de Mencos. It is associated with a tall forest in which the following trees predominate: *yaxnic*, *chicozapote*, *chintoc*, *guaya*, *puntero*, *pimienta*, *velerio*, *zapotillo*, *jesmo*, and *palma de guano*.

The plaza is located on a hill. It is integrated by two structures, one of them is L-shaped and occupies the north and west sectors, while a rectangular mound defines the east side, which shows a looting on the front façade.

<i>Rojo Group</i>					
PATIO	STRUCTURE	LENGTH	WIDTH	HEIGHT	LOOTING
1	1	L= 15.00/10.00	4.00	0.60	
	2	6.00	3.00	1.50	1 West

Appendix 4

BAJO LA PITA REGION, EAST ZONE

Copal Group
(Code 01)

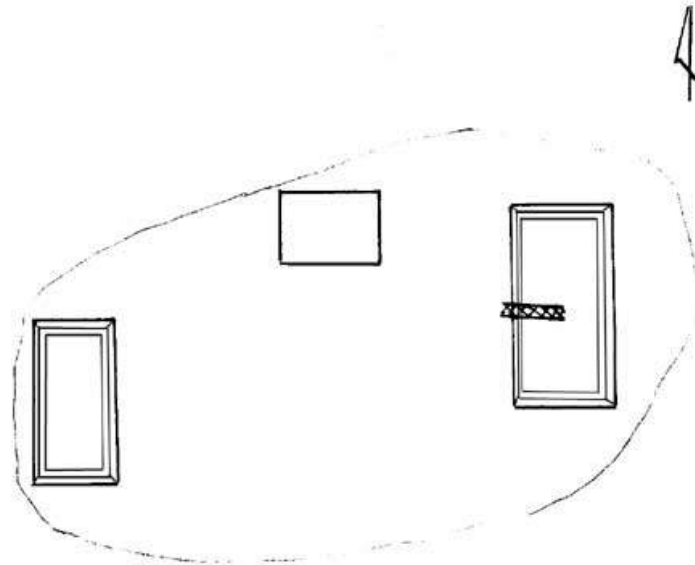

Naranjo, Petén
Periferia SW-Grupo 01
Zona Bajo La Pita Este
Escala 1:200

This group is located on the following coordinates: 16 Q0259104 and 1895626 UTM, to the west of the road leading to the ruins of IDAEH's camp in Naranjo. It is associated with a forest in which the following trees predominate: *ramón*, *cedrillo*, *subín*, *puntero*, *zapotillo*, *palo de agua*, *pimienta*, *matapalo*, *cedro*, *chicozapote*, *jobo*, *cedrillo blanco*, *laurel*, as well as *escobo*, *botán*, and *corozo* palms.

A plaza open to the south is on an elevated foundation, it is integrated by three structures organized in a symmetrical fashion. This compound's function appears to have been of domestic nature. The structure sitting on the north side is of rectangular shape and is the smallest one in the compound. On the east side there is a low rectangular foundation, which has a looter's trench in the central area of the front façade. The patio's west sector is defined by another foundation which probably pertains to a palace which had a roof made of perishable material.

<i>Copal Group</i>					
PATIO	STRUCTURE	LENGTH	WIDTH	HEIGHT	LOOTING
1	1	4.20	3.10	0.40	
	2	8.60	4.20	0.50	1W
	3	6.90	3.40	1.50	

La Ramonera Group
(Code 02)

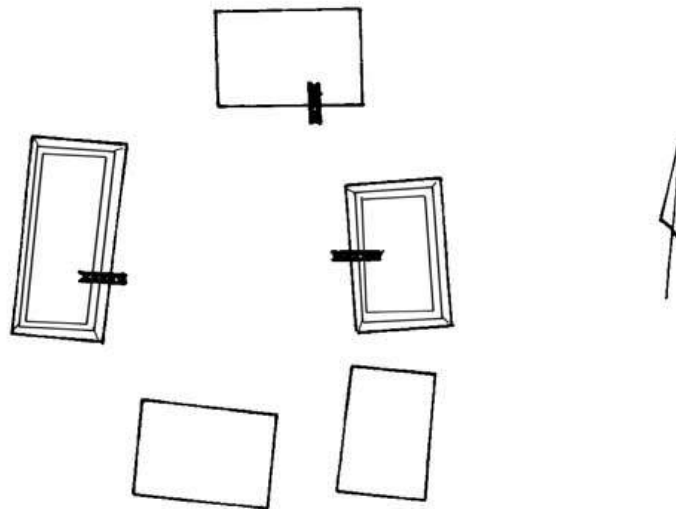

Naranjo, Petén
Periferia SW-Grupo 02
Zona Bajo La Pita Este
Escala 1:200

This group is located on the following coordinates: 16 Q0259227 and 1895060 UTM, to the west of the path leading to IDAEH's camp in Naranjo, on a natural elevation (257 m asl) with flat terrain on the top. It is associated with a tall, dense forest in which the following trees predominate: *ramón*, *cedrillo*, *subín*, *puntero*, *zapotillo*, *palo de agua*, *pimienta*, *matapalo*, *cedro*, *chicozapote*, *jobo*, *cedrillo blanco*, *laurel*, as well as *escobo*, *botán* and *corozo* palms.

This group consists of a plaza integrated by four structures organized in a symmetrical fashion on a foundation. The building occupying the east side is of

rectangular shape and probably pertains to a palace which had a roof made of perishable material. In the south side there is a probable low sanctuary with square base. The most outstanding structure in the compound is located on the west side, and pertains to a U-shaped palace with an open east side. It has a looter's trench on the back side.

<i>La Ramonera Group</i>					
PATIO	STRUCTURE	LENGTH	WIDTH	HEIGHT	LOOTING
1	1	6.60	4.40	0.50	1S
	2	6.60	4.40	1 m	1W
	3	5.60	4.00	0.40	
	4	6.00	4.20	1.00	
	5	8.80	8.80	4.00	1E

La Chorchá Group
(Code 04)

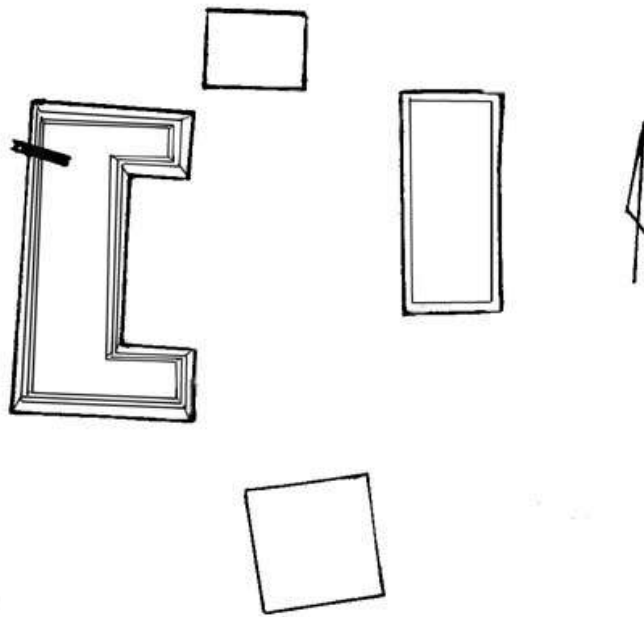

Naranjo, Petén
 Periferia SW-Grupo 04
 Zona Bajo La Pita Este
 Escala 1:200

This group is located on the following coordinates: 16 Q0258993 and 1895171 UTM, on the west side of the path leading to IDAEH's camp in Naranjo, on a natural elevation with flat terrain on the top (257 m asl). It is associated with tall, dense forest in which the following trees predominate: *ramón, cedrillo, subín, puntero, zapotillo, palo de agua, pimienta, matapalo, cedro, chicozapote, jobo, cedrillo blanco, laurel*, as well as *escobo, botán*, and *corozo* palms.

This group consists of a plaza integrated by four structures organized in a symmetrical fashion on a foundation. The building sitting on the east side is of rectangular shape, and probably pertains to a palace which had a roof made of perishable material. On the south side there is a probable low sanctuary of square base. The most outstanding structure in the compound is located on the west side, and pertains to a U-shaped palace with an open space on the east side. It has a looter's trench in the back side.

<i>La Chorchá Group</i>					
PATIO	STRUCTURE	LENGTH	WIDTH	HEIGHT	LOOTING
1	1	4 m	3.40	0.50	
	2	9.40	4 m	1 m	
	3	5	5	0.40	
	4	13 m	2 m Ala N= 6.40 Ala S= 7.40	1.00	1 W

Hormigas Blancas Group
(Code 06)

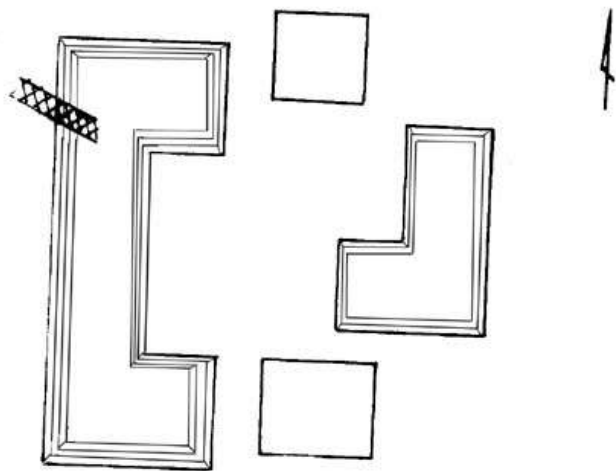

Naranjo, Petén
 Periferia SW-Grupo 06
 Zona Bajo La Pita Este
 Escala 1:200

This group is located on the following coordinates: 16 Q0258999 and 1895194 UTM, on the west side of the main road leading to IDAEH's camp in Naranjo. It is associated with a forest in which the following trees predominate: *zapotillo*, *palo de agua*, *matapalo*, *chicozapote*, *jobo*, *cedrillo blanco*, *laurel*, as well as *escobo*, *botán*, and *corozo* palms.

This group consists of a plaza integrated by four structures of several shapes and sizes, whose function appears to have been linked with residential and administrative aspects. The structure on the north side is square in shape and it probably was a low sanctuary. In the plaza's east sector there is a L-shaped structure with a segment located in the south sector and directed toward the west. Apparently this is an example of a structure which originally had a rectangular shape but then it was modified to make it wider. In the patio's south sector there is a low rectangular platform, which probably had a domestic function. The most important building is located in the west side of the plaza; it consists of a palace with a U-format which has a looter's tunnel in the back side.

<i>Hormigas Blancas Group</i>					
PATIO	STRUCTURE	LENGTH	WIDTH	HEIGHT	LOOTING
1	1	4 m	4	0.50	
	2	9.20	3.80	1.50 m	
	3	5	4.20	0.50	
	4	13 m	3 m Ala N= 4.40 Ala S= 4.40	3.00	1 W

Cotorrito Group
(Code 07)

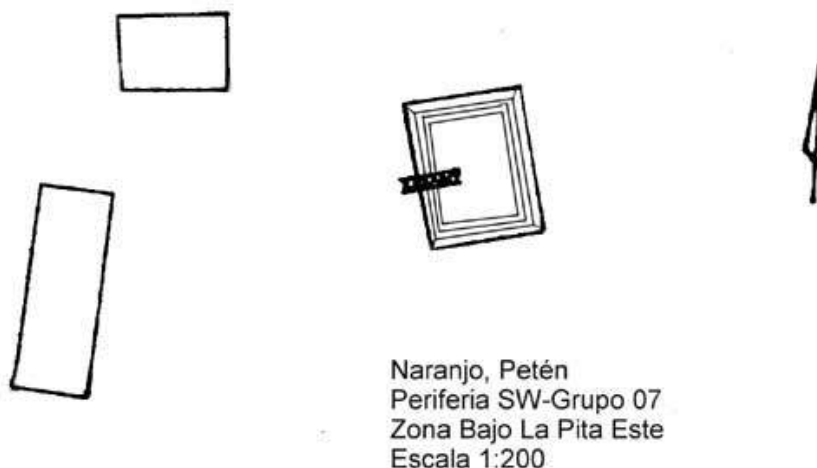

This group is located in the following coordinates: 16 Q0259114 and 1895203 UTM, on the west side of the path leading to IDAEH's camp in Naranjo, on a natural elevation (257 m asl) with flat terrain on the top. It is associated with a tall, dense forest, in which the following trees predominate: *ramón, cedrillo, subín, puntero, zapotillo, palo de agua, pimienta, matapalo, cedro, chicozapote, jobo, cedrillo blanco, laurel*, as well as *escobo, botán*, and *corozo* palms.

This group consists of a plaza integrated by three structures forming a plaza compound open to the south. In the east sector there is a building of rectangular shape which may have been a sanctuary. This building is a little shifted to the north, and its axis is quite slanted. There is a looter's trench on the west façade. In the north side shifted to the west there is a low mound of rectangular base. The plaza's west sector is defined by a long, low rectangular platform. This is considered to be a residential group with a domestic function.

<i>Cotorrito Group</i>					
PATIO	STRUCTURE	LENGTH	WIDTH	HEIGHT	LOOTING
1	1	4.00	3.00	0.50	
	2	6.00	4.40	1.00	1W
	3	7.80	3.00	0.40	

Zanate Group
(Code 09)



This group is located on the following coordinates: 16 Q0259252 and 1894471 UTM, on the west side of the path leading to IDAEH's camp in Naranjo, on a natural elevation. It is associated with a tall, dense forest, in which the following trees predominate: *ramón*, *cedrillo*, *subín*, *puntero*, *zapotillo*, *palo de agua*, *pimienta*, *matapalo*, *cedro*, *chicozapote*, *jobo*, *cedrillo*, *blanco*, *laurel*, as well as *escobo*, *botán*, and *corozo* palms.

This group consists of a plaza integrated by three structures forming a compound open to the south. This compound appears to have had a ceremonial function. In the north side one can see a wide, low platform with rectangular base. The group's east sector is occupied by a sanctuary with a square base, which has a looter's tunnel on the west façade; the looters also dug a pit in the building's base at the level of the plaza. The west sector is defined by another pyramidal sanctuary.

Zanate Group					
PATIO	STRUCTURE	LENGTH	WIDTH	HEIGHT	LOOTING
1	1	6.00	4.60	0.50	
	2	5.20	5.20	2.50	1W
	3	5.00	4.80	3.00	

Tapir Group
(Code 10)

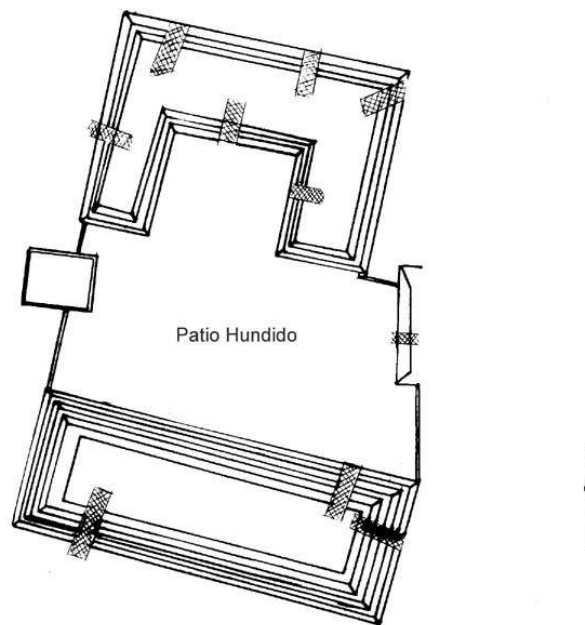

Naranjo, Petén
Periferia SW- Grupo 10
Zona Bajo La Pita Este
Escala:1200

This group is located on the following coordinates: 16 Q0259120 and 1894519 UTM, on the west side of the path leading to IDAEH's camp in Naranjo, on a natural elevation with flat terrain on the top (257 m asl). It is associated with a tall, dense forest, in which the following trees predominate: *ramón*, *cedrillo*, *subín*, *puntero*, *zapotillo*, *palo de agua*, *pimienta*, *matapalo*, *cedro*, *chicozapote*, *jobo*, *cedrillo blanco*, *laurel*, as well as *escobo*, *botán*, and *corozo* palms.

This group consists of a plaza integrated by four structures forming a quadrangle or sunken patio. On the north side there is a large-sized palace with a U-format, whose appendages are on the south side. This group was affected by six looter's

tunnels, which brought to light several structures of various cultural periods. In the east there is a rectangular platform to which are integrated walls bounding the plaza on the north and south sides. In the compound's south sector there is a palace of great size, showing looter's tunnels on the north, east and south facades. The west side is occupied by a platform which might pertain to a service structure. This is regarded as a residential and administrative group associated with the higher elite.

<i>Tapir Group</i>					
PATIO	STRUCTURE	LENGTH	WIDTH	HEIGHT	LOOTING
1	1 "U"	17.50	6.50 Eaves 6.00	2.50	3 N; 2E; 1S; 1W
	2	7.00	3.50	1.00	1W
	3	22.80	8.40	3.50	1N; 1E; 1S
	4	4.20	3.40	1.50	

Pájaro Carpintero Group
(Code 12)

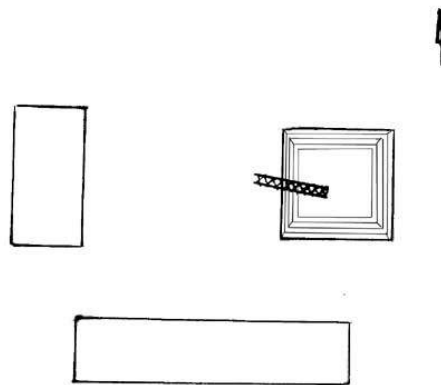

Naranjo, Petén
Periferia SW-Grupo 12
Zona Bajo La Pita Este
Escala 1:200

This group is located on the following coordinates: 16 Q0259273 and 1894680 UTM, on the west side of the path leading to IDAEH's camp in Naranjo, on a natural elevation with flat terrain on the top. It is associated with a tall forest, in which the following trees predominate: *ramón, cedrillo, subín, puntero, zapotillo, palo de agua, pimienta, matapalo, cedro, chicozapote, jobo, cedrillo blanco, laurel*, as well as *escobo, botán, and corozo* palms.

This group consists of a plaza integrated by three structures forming a compound which is open to the north. The compound's function appears to have been residential. On the east side there is a sanctuary of square plan, which has a looter's tunnel on the west façade. The patio's south sector is defined by a long, low platform. Toward the west there is another residential platform.

<i>Pájaro Carpintero Group</i>					
PATIO	STRUCTURE	LENGTH	WIDTH	HEIGHT	LOOTING
1	1	6.80	6.80	2.50	1W
	2	16.60	4.00	0.50	
	3	8.50	4.20	0.50	

Los Chultunes Group
(Code 14)

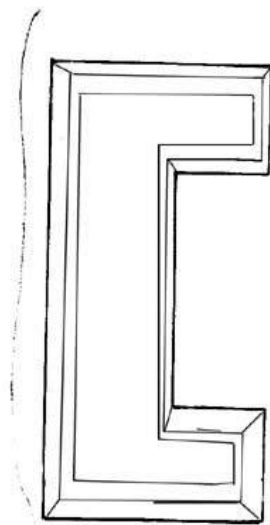

Naranjo, Petén
Periferia SW-Grupo 14
Zona Bajo La Pita Este
Escala 1:200

This group is located on the following coordinates: 16Q 0259059 and UTM 18 942965 near the road leading to IDAEH's camp, on a natural elevation. It is associated with a tall, dense forest, in which the following trees predominate: cola de pava, ramón, mano de león, chacaj, zapotillo, sunso macho, cilión, barío,

malerio, pimienta, subín, sacuayun, cedro, puntero, guarumo, as well as corozo palms.

This group consists of a single plaza defined by a U-shaped structure of great dimensions which is open to the northeast. In the area of the plaza two chultunes were found. No lootings are seen here.

<i>Los Chultunes Group</i>					
PATIO	STRUCTURE	LENGTH	WIDTH	HEIGHT	LOOTING
1	1 "U"	22	6.00 (Ala N=4.40 Ala S= 4.40)	2.5 m	

Los Loros Group
(Code 19)

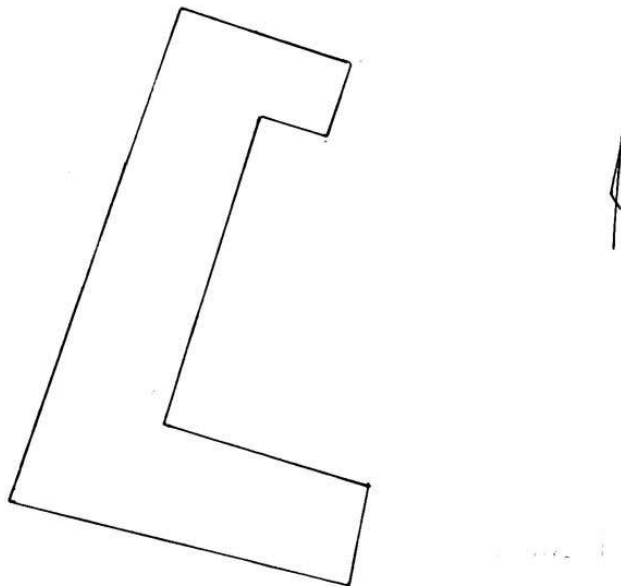

Naranjo, Petén
Periferia SW-Grupo 19
Zona Bajo La Pita Este
Escala 1:200

This group is located on the following coordinates: 16 Q0259065 and UTM 1895106, near the road leading to IDAEH's camp, on a natural elevation. It is associated with a tall, dense forest, in which the following trees predominate:

cola de pava, ramón, mano de león, chacaj, zapotillo, sunso macho, cilión, barío, malerio, pimienta, subín, sacuayun, cedro, puntero, guarumo, as well as corozo palms.

This group consists of a single plaza defined by a U-shaped structure of great dimensions which is open to the east. The building shows a strong deviation to the northeast. Two chultunes were found in the area of the plaza. No lootings are seen here.

<i>Los Loros Group</i>					
PATIO	STRUCTURE	LENGTH	WIDTH	HEIGHT	LOOTING
1	1 "U"	32	6.50 (Ala N =11.20 Ala S = 21.80)	4.5 m	

Granadilla Group
(Code 20)

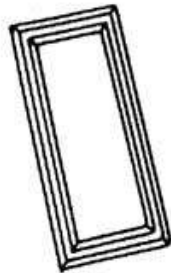

Naranjo, Petén
Periferia SW- Grupo 20
Zona Bajo La Pita Este
Escala:1200

This group is located on the following coordinates: 16Q 0259276 and UTM 1895203, near the main road leading to IDAEH's camp, on a natural elevation. It is associated with a tall, dense forest, in which the following trees predominate: *cola de pava, ramón, mano de león, chacaj, zapotillo, sunso macho, cilión, barío,*

malerio, pimienta, subín, sacuayun, cedro, puntero, guarumo, as well as corozo palms.

This group consists of a single plaza defined by a wide foundation on which sits a rectangular structure which defines the east side. This building shows a strong deviation toward the northwest. There is a looting in the structure's west façade.

<i>Granadilla Group</i>					
PATIO	STRUCTURE	LENGTH	WIDTH	HEIGHT	LOOTING
1	1	10 m	4.20	2 m	1 W

Zancudero Group
(Code 21)

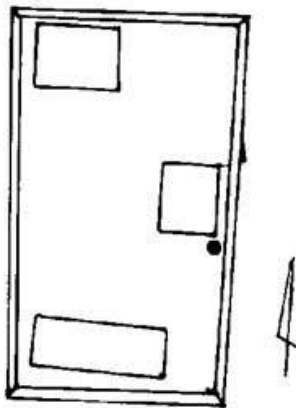

Naranjo, Petén
Periferia Oeste, Grupo 21
Zona Bajo La Pita Este
Escala 1;200

This group is located on the following coordinates: 16Q 0259200 and UTM 1894406, near the main road leading to IDAEH's camp, on a natural elevation. It is associate with a tall, dense forest in which the following trees predominate: cola de pava, ramón, mano de león, chacaj, zapotillo, sunso macho, cilión, barío, malerio, pimienta, subín, sacuayun, cedro, puntero, guarumo, and corozo palms.

This group consists of a single plaza defined by a foundation on which lie three rectangular structures which form a plaza which is open to the west. The compound seems to be domestic. No lootings are seen in the compound. Near the east building's southeast corner there is a chultun.

<i>Zancudero Group</i>					
PATIO	STRUCTURE	LENGTH	WIDTH	HEIGHT	LOOTING
1	1	3.40	2.80	0.50	
	2	3.00	2.50	0.50	
	3	5.50	2.20	0.50	

Nido de Cocochana Group
(Code 31)

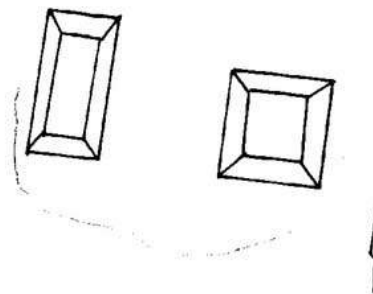

Naranjo, Petén
 Periferia Oeste, Grupo 31
 Zona Bajo La Pita Este
 Escala 1;200

This group is located on the following coordinates: 16 Q259146 and UTM 18 94263, near the road leading from IDAEH's on a natural elevation. It is associated with a tall, dense forest in which the following trees predominate: *cola de pava*, *ramón*, *mano de león*, *chacaj*, *zapotillo*, *sunzo macho*, *cilión*, *barío*, *malerio*, *pimienta*, *subín*, *sacuayun*, *cedro*, *puntero*, *guarumo*, and *corozo* palms.

This group consists of a single plaza defined by two structures which define the east and west sides, leaving the north and south spaces open. The structure on the east side has a square foundation, while the one in front is of rectangular plan. No lootings are seen here.

<i>Nido de Cocochana Group</i>					
PATIO	STRUCTURE	LENGTH	WIDTH	HEIGHT	LOOTING
1	1	5.20	5.20	1.50	
	2	7.20	4.00	1.50	

Cenzontle Group
(Code 42)

Naranjo, Petén
Periferia SW- Grupo 42
Zona Bajo La Pita Este
Escala:1200

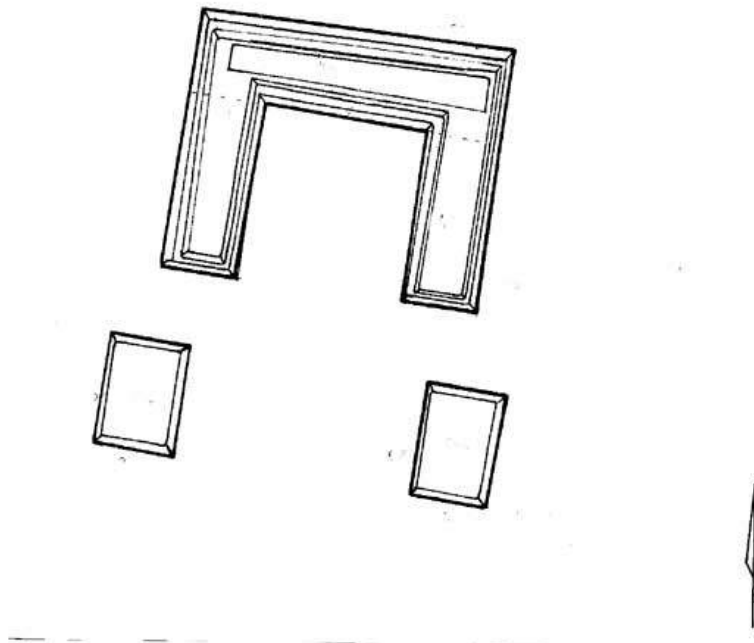

This group is located on the following coordinates: 16 Q259484 and 1895197 UTM, on a natural elevation to the north of the road leading from IDAEH's camp to Naranjo's zone of major ruins or epicenter. It is associated with a tall, dense primary forest, in which the following trees predominate: *botán, chacaj, chicozapote, sumso, amate, botán, chacaj, escobo, ixcanal, laurel, ramón, subin, indio desnudo, yaya, and mano de león.*

The plaza is located on an artificial, platform-like elevation. The plaza is integrated by three structures. The north side is defined by a tall structure with a U-format and two mounds on the east and west sides. The south side is open. No lootings are seen here.

<i>Cenzontle</i>					
PATIO	STRUCTURE	LENGTH	WIDTH	HEIGHT	LOADING
1	1	U= 14.20	2 segmt =11.80	4.00/2.50	
	2	5.00	4.00	1.00	
	3	5.00	4.00	1.00	

Appendix 5

BAJO LA PITA REGION, SOUTH ZONE

Guamil Group
(Code 52)

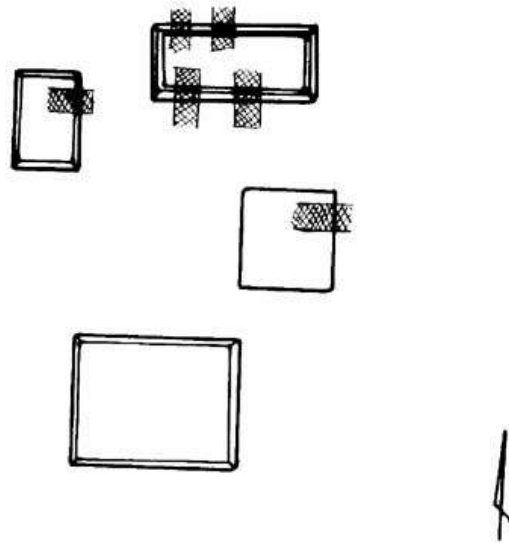

Naranjo, Petén
Periferia SW- Grupo 52
Zona Bajo La Pita Sur
Escala:1200

This group is located on the following coordinates: 16 Q0258164, and 1894419 UTM, near the house of the Burgos family, on a small natural elevation. It is associated with a vegetation of *corozo* and *escobo* palms, and *guamil*.

The group pertains to a Plaza Plan 2 format, although the four structures which integrate it are organized in an asymmetrical way. The north side is defined by a rectangular structure which was affected by four looter's trenches, two on the front side (3.80 x 1 m and 2 x 1 m), and two on the back side (2.90 x 0.90 m and 1.80 x 1 m). The sanctuary sitting on the east side was preyed upon by a trench (2 x 1 m) on the back side. The position of the structure occupying the south side is asymmetrical compared to the north one, which is also seen on the west side, where the corresponding residential platform is displaced in the northwest sector of the patio. The latter has a looter's trench (2 x 1.40 m) on the façade. No samples of archaeological materials were collected from any of the lootings.

<i>Guamil</i>					
PATIO	STRUCTURE	LENGTH	WIDTH	HEIGHT	LOOTING
1	1	9.00	4.50	2.00	2 North; 2 South
	2	5.00	5.00	0.50	1- East
	3	9.00	7.00	1.00	
	4	6.00	4.00	1.00	1- East

Casa Burgos Group
(Code 53)

Naranjo, Petén
Periferia SW- Grupo 53
Zona Bajo La Pita Sur
Escala: 1200

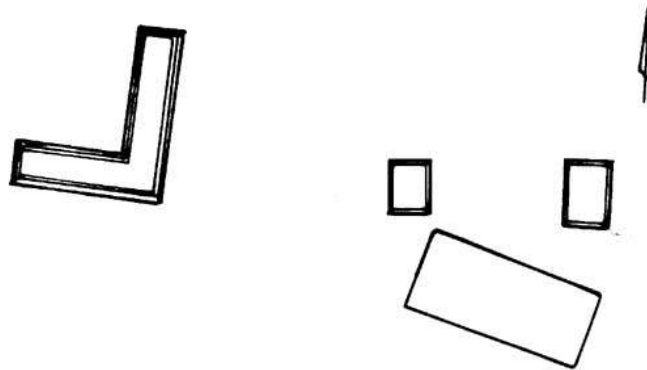

This group is located on the following coordinates: 16 Q0258050, and 1894705 UTM, it is adjacent to the house of the Burgos family, on the south side of the road. The environment is of bajo type, including *corozo* palms and *guamiles*. The group is integrated by two patios.

Patio 1

This patio consists of three platforms of rectangular plan, which delimit three sides of the patio, while the north sector is open. No lootings were seen here.

Patio 2

This patio is located to the west of Patio 1, it consists of a long, L-shaped platform which defines the east and south sides. No lootings were seen here.

<i>Casa Burgos</i>					
PATIO	STRUCTURE	LENGTH	WIDTH	HEIGHT	LOOTING
2	4	L= 21 (13)	5.50	2.00	
1	2	22.00	10.00	0.50	
1	1	8.00	6.00	1.00	
1	3	8.00	4.50	1.00	

Las Vacas Group
(Code 54)

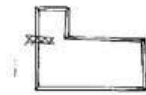

Naranjo, Petén
Periferia SW-Grupo 54
Zona Bajo La Pita Sur
Escala 1:750

This group is located on the following coordinates: 16 Q0258473, and 1894595 UTM, at a height of 260 m asl in an area linked with Bajo La Pita. It is associated with a forest of *ramón* and *chacaj* trees, as well as *escobo*, *guano* and *corozales* palms.

This group is integrated by four plazas organized east-west, which include structures of several sizes, forms and functions. Plaza 1 is integrated by two

sanctuaries delimiting the east and west sides. The temple on the east side has two looter's tunnels, one on the main façade leading to the patio, and one which destroyed a great part of the southeast corner. In both lootings there is evidence of substructures pertaining to the first part of the Late Classic period.

Plaza 2 consists of a pyramidal temple of square base occupying the east sector, while a rectangular vaulted palace confronts it on the west. The temple has five looter's tunnels and trenches, while the palace has four tunnels. The lootings show building periods which may pertain to the Early Classic period. Osteological remains were found, which indicates that burials were preyed upon.

Plaza 3 is dominated in the north sector by a U-shaped building, with the appendages oriented toward the south. This building has a total of six looter's trenches and tunnels.

Plaza 4 is located some 53 m to the north of Plaza 2. Plaza 4 is integrated by an L-shaped structure occupying the south and west sectors. A looter's trench was identified in the west sector. This sector was preyed upon by a tunnel-trench (11 m) which cuts through it along the east-west axis. At least two building periods can be seen here. The looters also excavated a pit in front of the building. On the west side there is a palace of rectangular base, which was preyed upon by three tunnels on its north, east, and west facades. The architecture is of masonry, showing at least three building stages indicated by three stucco floors over which rest walls of well-placed upright limestone rocks. There was at least one vaulted precinct. We collected material from the Late Classic and Terminal Classic periods, as well as some polychrome sherds and grindstones. Directly to the south of the palace are two low residential platforms, one of which is of square base while the one located more to the south is rectangular with its axis notably slanted to the northwest.

<i>Las Vacas</i>					
PATIO	STRUCTURE	LENGTH	WIDTH	HEIGHT	LOOTING
1	1	7.40	6.00	2.50	1SE; 1W
	2	5.00	4.00	1.50	
2	1	8.40	8.40	5.00	1N;1E; 1S; 2W
	2	18.40	7.00	4.00	2E; 2W
3	1	16.00	4.40 Eave E=5 m Eave W=3.40	3.00	2N;1E; 1S; 2W
4	1	15.00	7.20 Eave N=4 m	5.00	1 W

Laurel Group
(Code 55)

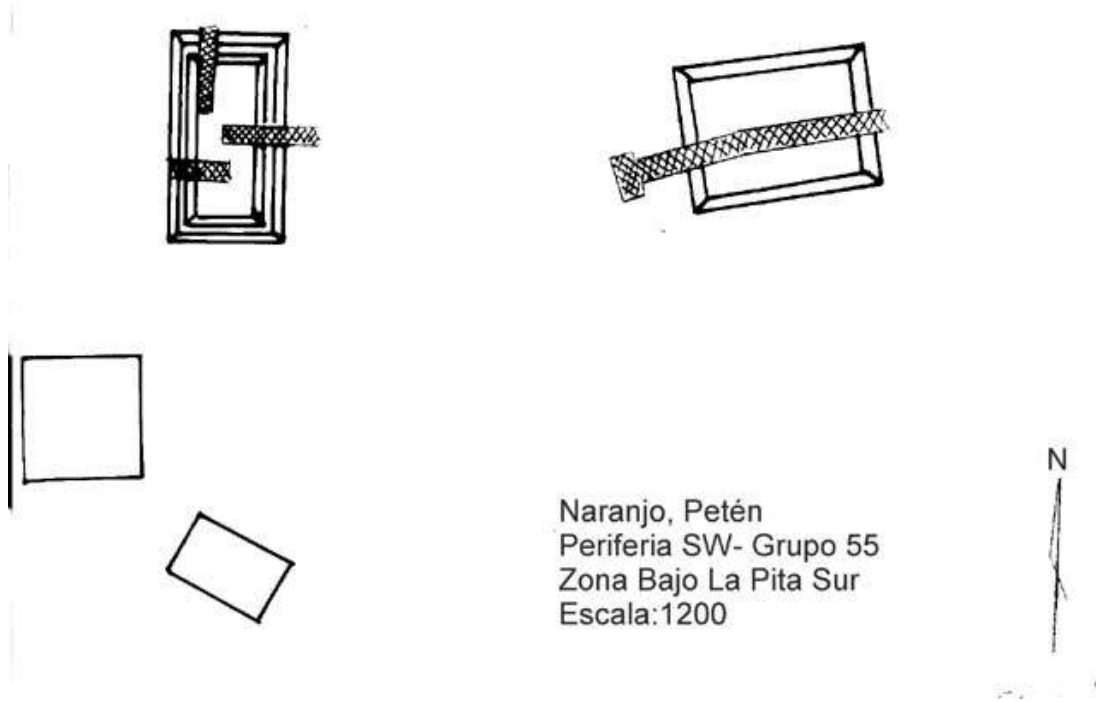

Naranjo, Petén
Periferia SW- Grupo 55
Zona Bajo La Pita Sur
Escala:1200

This group is located on the following coordinates: 16 Q0258326 and 1894360 UTM, at a height of 283 m asl on a small natural elevation. It is associated with a forest with the following trees: *ramón*, *chacaj*, *cedrillo*, *laurel*, *zapotillo*, *yaxnic*, and *mano de león*. There also are *escobo* and *guano* palms.

This group has an arrangement of an irregular plaza open to the north and south. It is integrated by four structures which are organized in an asymmetrical way. The east side is occupied by a sanctuary of rectangular base. The façade is located in the narrowest sector of the structure, it is oriented toward the plaza. This group has been preyed upon by a tunnel-trench (11 m) which cuts through it on an east-west axis. At least two building periods can be seen. The looters also excavated a pit in front of the building. On the west side there is a palace of rectangular base, which was preyed upon with three tunnels on its north, east and west facades. Architecture is of masonry, showing at least three building stages indicated by three stucco floors on top of which rest walls of well-placed upright limestone rocks. It had at least one vaulted precinct. We collected material from the Late Classic and Terminal Classic periods, as well a some polychrome sherds and grindstones. Directly to the south of the palace are two low residential platforms, one of them is of square base while the one located

more to the south is rectangular with the axis notably slanted toward the northwest.

<i>Laurel</i>					
PATIO	STRUCTURE	LENGTH	WIDTH	HEIGHT	LOOTING
1	1	7.20	4.80	3.00	1 east-west
	2	4.00	2.60	0.50	
	3	5.00	5.00	0.80	
	4	8.40	4.80	3.00	1E, 1N, 1W

Ceiba Group
(Code 56)

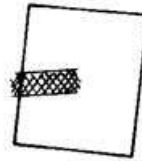
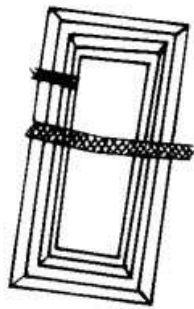

Naranjo, Petén
Periferia SW- Grupo 56
Zona Bajo La Pita Sur
Escala:1200

This group is located on the following coordinates: 16 Q0258512 and 1894326 UTM, to the east of an old truck road which branches off the road leading to Naranjo. This group occupies the high part of a hill at a height of 266 m asl, it is associated with the following trees: *chacaj*, *cedro*, *ceiba*, *yaxnic*, *chicozapote*, *cilión*, *ramón*, and *jobo*. There also are *corozo* and *escobo* palms, as well as *guamil* vegetation.

This group follows an open plaza format, integrated on the north and south sectors by two structures showing a notable deviation to the east. The east sector is defined by a low sanctuary of rectangular plan, which has a looter's trench (3 x 1.50 m) on the main (west) façade. The west side of the plaza is

defined by a rectangular palace-like structure, which was affected by a looter's tunnel-trench (8 m) which cuts completely through it along the central axis. The looting allows one to see some two building stages indicated by stucco floors, as well as walls with upright ashlar stones and part of a bench. Another tunnel of smaller dimensions (2.80 m) is seen on the back facade, near the northwest corner.

<i>Ceiba Group</i>					
PATIO	STRUCTURE	LENGTH	WIDTH	HEIGHT	LOOTING
1	1	6.00	5.00	0.60	1 West
	2	12.00	6.00	3.00	2 West

Guaya Group
(Code 58)

Naranjo, Petén
Periferia SW- Grupo 58
Zona Bajo La Pita Sur
Escala:1200

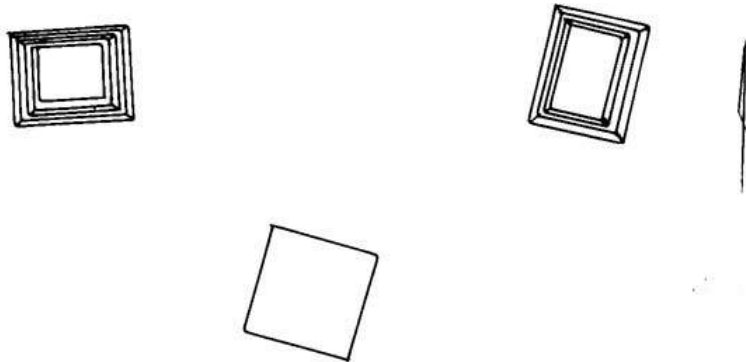

This group is located on the following coordinates: 16 Q0258396 and 1894152 UTM, on the east side of an old truck road which branches off the road leading to Naranjo. This group occupied the high part of a hill at a height of 266 m asl. It is associated with the following trees: *guaya*, *matapalo*, *pimienta*, *ramón*, *puntero*, as well as *corozo* and *escobo* palms.

This group follows an open plaza format on the north sector. It is integrated by three structures showing a notable deviation toward the east and west. The east

sector is defined by a sanctuary of some two bodies of rectangular plan, which is in front of another similar sanctuary occupying the west part of the plaza. The south side is defined by a low structure which may also have had a ritual function. No lootings were found in this group.

<i>Guaya</i>					
PATIO	STRUCTURE	LENGTH	WIDTH	HEIGHT	LOOTING
1	1	5.80	4.80	2.00	
	2	5.80	4.60	2.50	
	3	5.20	5.20	4.00	

Quina Group
(Code 59)

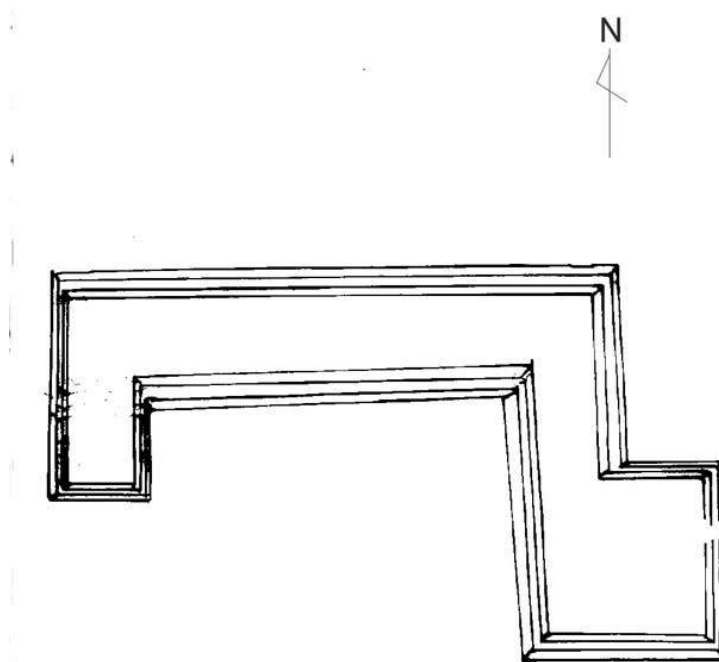

Naranjo, Petén
Periferia SW- Grupo 59
Zona Bajo La Pita Sur
Escala:1200

This group is located on the following coordinates: 16 Q0258555 and 1893970 UTM, on the west side of an old truck road which branches off the road leading to Naranjo. He group occupies the high part of a hill at a height of 303 m asl. It is

associated with the following trees: quina, jesmo, copal, chacaj, amate, and ramón.

This group consists of an apparently isolated, large-sized palace with a "U" shape with appendages. It has five lootings, three on the west side, one in the north and one in the south. Pottery was collected from the north looting, where one can see a wall covering a fine, loose fill of small stones. The lootings are recent, probably from the current year. In number five one can see two walls and three stucco floors.

<i>Quina Group</i>					
PATIO	STRUCTURE	LENGTH	WIDTH	HEIGHT	LOOTING
1	1	39.00	8.00 a 22.00	3.00	3W;1N & 1S

Tres Cocochanes Group
(Code 60)

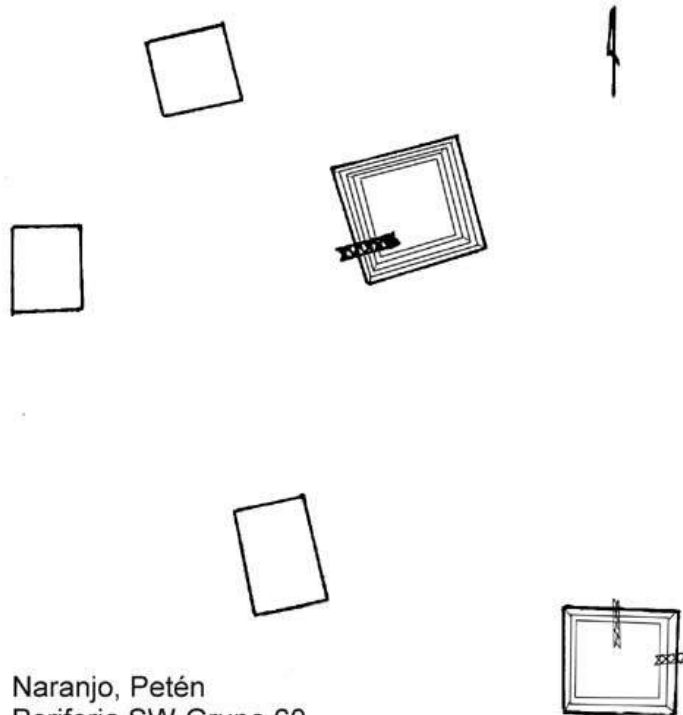

Naranjo, Petén
Periferia SW-Grupo 60
Zona Bajo La Pita Sur
Escala 1:200

This group is located on the following coordinates: 16 Q0257382 and 1893595 UTM, at an altitude of 297 m asl. It is accessed by following a truck road which intersects the road leading to Naranjo, near a cattle ranch belonging to the Burgos family. It is associated with a forest with the following trees: *copal*, *subín*, *ceibillo*, *ramón*, *chacaj*, *cedro*, *pimienta*, *manax*, and *mano de león*.

The compound is located on a small elevation, and appears to be an annex of the U-shaped palace identified with the name of Quina Group.

Patio 1

The group pertains to an irregular plaza arrangement open to the south. It is integrated by three structures which are organized in a symmetrical fashion. The north side is occupied by a low, square-based structure, while the east side is occupied by a square-based sanctuary which may have had two bodies. On the façade in front of the plaza there is a looter's trench. The plaza's west side is occupied by a low rectangular platform. Somewhat removed, at some 9 m to the south, there is a low rectangular mound, with an elongated north-south axis, and some 51 m further south there is a square sanctuary showing two looter's tunnels, one on the north side and one to the east.

<i>Tres Cocochanes</i>					
PATIO	STRUCTURE	LENGTH	WIDTH	HEIGHT	LOOTING
1	1	6.00	4.40	0.35	
	2	8.80	6.40	2.00	1 west
	3	6.40	3.80	0.30	
	4	3.00	3.00	0.20	1E, 1N
	5	4.20	6.20	2.00	

Chicozapote Group **(Code 61)**

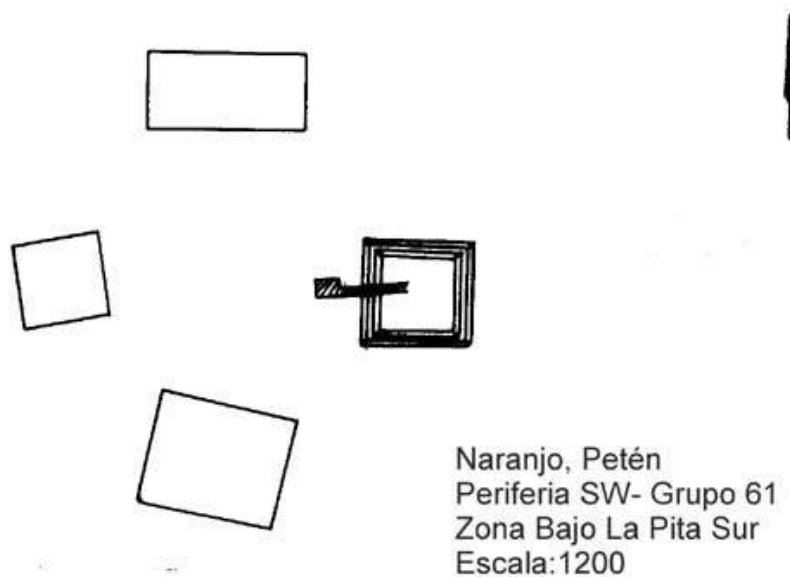

This group is located on the following coordinates: 16 Q0258907 and 1894292 UTM, on the east side of an old truck road which branches off the road leading to Naranjo. The group sits on the high part of a hill at an altitude of 325 m asl. It is associated with trees of *chicozapote*, *guaya*, *zapotillo*, *ramón*, and *manax*.

The group follows an open plaza format in the north sector. It is integrated by three structures of rectangular plan. The east side is occupied by a low sanctuary of rectangular base. The façade oriented toward the plaza is located in the narrowest sector of the structure; it shows a looter's trench. The south side is occupied by a long, low foundation, while the west side is dominated by a 3 m-high palace which has two looter's tunnel-trenches. Ceramic material was recovered from the lootings in structures 1 and 3. Human bones were found in structure 1, besides the trench, together with some major pottery fragments. In another looting in the structure 3 there were polychrome sherds. The lootings are recent, perhaps from 2006.

<i>Chicozapote</i>					
PATIO	STRUCTURE	LENGTH	WIDTH	HEIGHT	LOOTING
1	1	5.25	3.00	0.50	1 W
	2	9.40	3.00	0.50	
	3	18.20	6.20	0.50	2E

Sare Group
(Code 68)

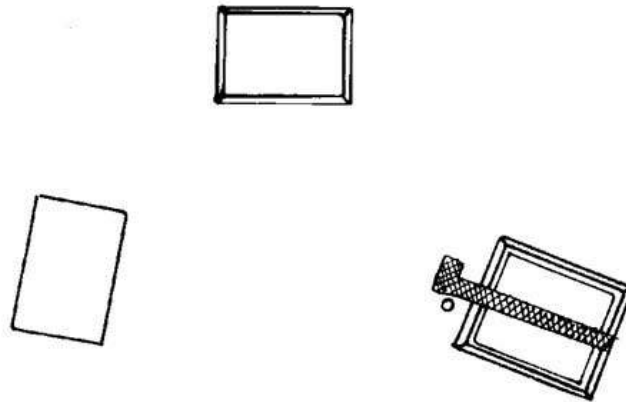

Naranjo, Petén
Periferia SW- Grupo 68
Zona Bajo La Pita Sur
Escala:1200

This group is located on the following coordinates: 16 Q0257340 and 1894067 UTM, on the east side of an old truck road which branches off the road leading to Naranjo. The group sits on the high part of a hill at an altitude of 304 m asl. It is associated with the following trees: *sare*, *guaya*, *ramón*, *copal*, and *chacaj*.

This group follows a plaza format open to the south. It is integrated by three structures, two of which show a notable deviation to the east. The east sector is defined by a sanctuary of some two bodies of rectangular plan, whose façade is in the narrowest sector of the structure. A *chultún* is associated with the structure, and there is a looter's tunnel-trench (8.80 m) which starts with a pit. The plaza's west side is occupied by a low rectangular platform, like the one defining the group's north side. It is thought that both structures may have had a domestic function.

<i>Sare</i>					
PATIO	STRUCTURE	LENGTH	WIDTH	HEIGHT	LOOTING
1	1	5.80	4.80	2.00	
	2	5.80	4.60	2.50	
	3	5.20	5.20	4.00	

Mano de Piedra Group
(Code 70)

Naranjo, Petén
 Periferia SW- Grupo 70
 Zona Bajo La Pita Sur
 Escala: 1200

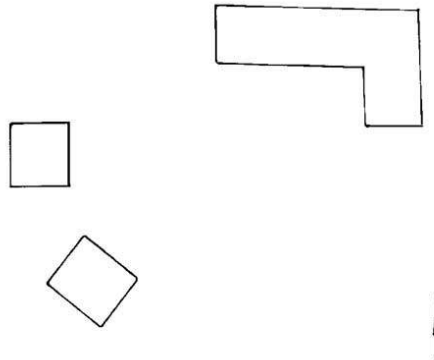

This group is located on the following coordinates: 16 Q0258044 and 1894791 UTM, on the east side of an old truck road which branches off the road leading to Naranjo. The group occupies the high part of a hill at an altitude of 289 m asl. It is associated with the following trees: *chicozapote*, *cedrillo*, *mano de león*, *subín*, *copal*, *cola de pava*, *chintoc*, and *manax*.

This group follows an open plaza format in the south sector. It is integrated by three low structures. The northeast sector is defined by a long, L-shaped platform, while on the west side there are two low, square platforms which may have had a residential function. No lootings were found in this group.

<i>Mano de Piedra</i>					
PATIO	STRUCTURE	LENGTH	WIDTH	HEIGHT	LOOTING
1	1	14.00	4.00 y 8.00	1.00	
	2	5.00	4.80	0.50	
	3	4.00	4.00	0.50	

Papayero Group
(Code 72)

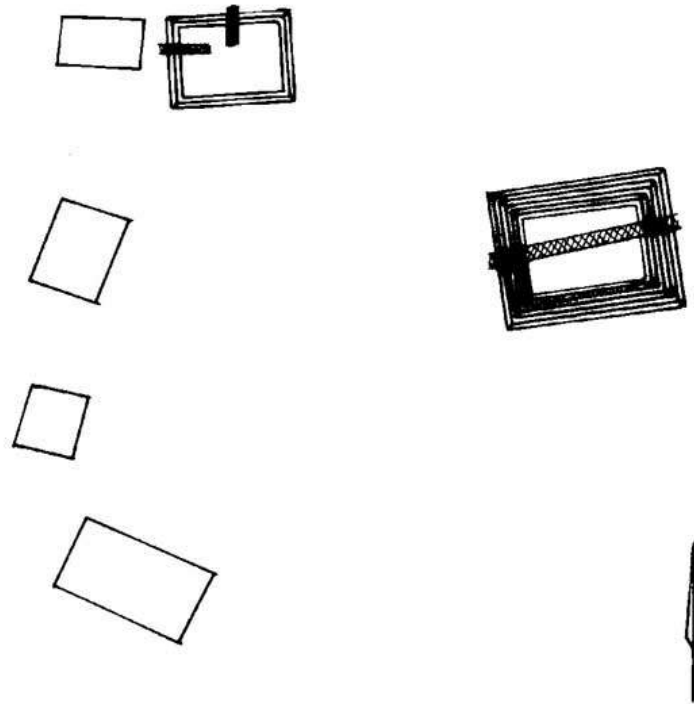

Naranjo, Petén
Periferia SW- Grupo 72
Zona Bajo La Pita Sur
Escala:1200

This group is located on the following coordinates: 16 Q0257382 and 1893595 UTM, at an altitude of 297 m asl on a small natural elevation. It is associated with a forest with the following trees: *copal*, *subín*, *ceibillo*, *ramón*, *chacaj*, *cedro*, *pimienta*, *manax*, and *mano de león*.

This group follows an irregular plaza format open to the south. It is integrated by six structures organized in an asymmetrical fashion. The east side is occupied by a sanctuary of rectangular base. The façade is in the narrowest sector of the structure, it is oriented toward the plaza. This group has been preyed upon by a tunnel-trench (10 m) which cuts through it on an east-west axis. At least two building periods can be seen. On the north side there is a structure of rectangular base, preyed upon by two trenches on the north and west facades. In the east side of the plaza three remarkably deviated rectangular platforms and a probable low sanctuary with square base are aligned with each other. There is a looting in

structure 6, which shows the following remains: sherds, a slate core, a calcite grindstone, a flint fragment, and a projectile point. A chultún of cylindrical plan (.50 x .50 m) is associated with structure 6. The materials were left on the upper part of the mound.

<i>Papayera</i>					
PATIO	STRUCTURE	LENGTH	WIDTH	HEIGHT	LOOTING
1	1	6.00	4.40	1.50	1 N, 1 W
	2	8.80	6.40	3.80	1 east-west
	3	6.40	3.80	0.80	
	4	3.00	3.00	0.80	1E, 1N, 1W
	5	4.20	6.20	0.50	
	6	4.00	3.00	0.50	

Chispera Group
(Code 73)

Naranjo, Petén
Periferia SW- Grupo 73
Zona Bajo La Pita Sur
Escala: 1200

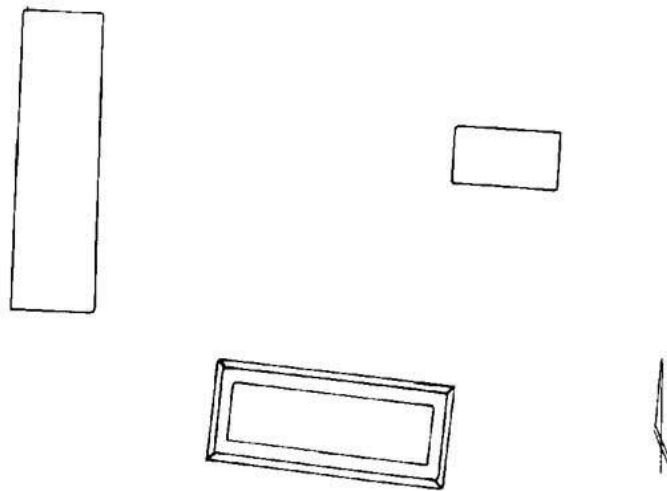

This group is located on the following coordinates: 16 Q0257476 and 1893647 UTM, on the east side of an old truck road that branches off the road leading to

Naranjo. The group sits on the high part of a hill at an altitude of 275 m asl. It is associated with the following trees: *chicozapote*, *cedrillo*, and *ramón*.

This group follows an open plaza format on the north sector, it is integrated by three structures. The east side is occupied by a low sanctuary of rectangular base, the façade is in the narrowest sector of the structure, oriented toward the plaza. The south side is occupied by a long foundation of two bodies, while on the west side there is a longitudinal platform. No lootings are seen here.

<i>Chispera</i>					
PATIO	STRUCTURE	LENGTH	WIDTH	HEIGHT	LOOTING
1	1	5.20	3.00	0.80	
	2	12.00	5.40	1.50	
	3	15.20	4.20	0.50	

Doncella Group
(Code 75)

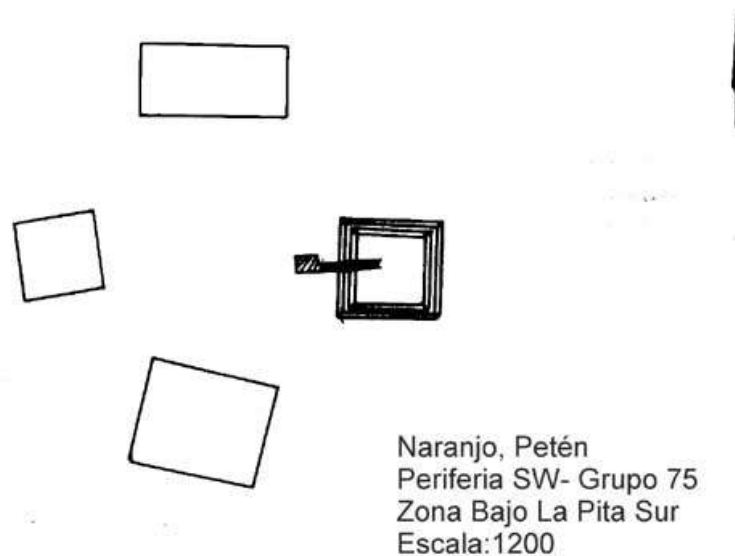

This group is located on the following coordinates: 16 Q0257382 and 1893595 UTM, at an altitude of 297 m asl, on a small natural elevation. It is associated with the following trees: *copal*, *subín*, *ceibillo*, *ramón*, *chacaj*, *cedro*, *pimienta*, *manax*, and *mano de león*.

This group follows an arrangement of the type plaza plan 2, and is integrated by four structures organized in a symmetrical fashion. The north side is defined by a rectangular foundation. In the east sector there is a sanctuary of rectangular base which has a looter's pit and tunnel that destroyed part of the façade. In the plaza's south and west sides there are two low rectangular structures which are characterized by having a strong deviation toward the northeast and northwest respectively.

<i>Doncella</i>					
PATIO	STRUCTURE	LENGTH	WIDTH	HEIGHT	LOOTING
1	1	6.00	4.40	0.60	
	2	8.80	6.40	1.00	1 west
	3	6.40	3.80	0.40	
	4	3.00	3.00	0.40	

La Sequía Group
(Code 77)

Naranjo, Petén
 Periferia SW- Grupo 77
 Zona Bajo La Pita Sur
 Escala:1200

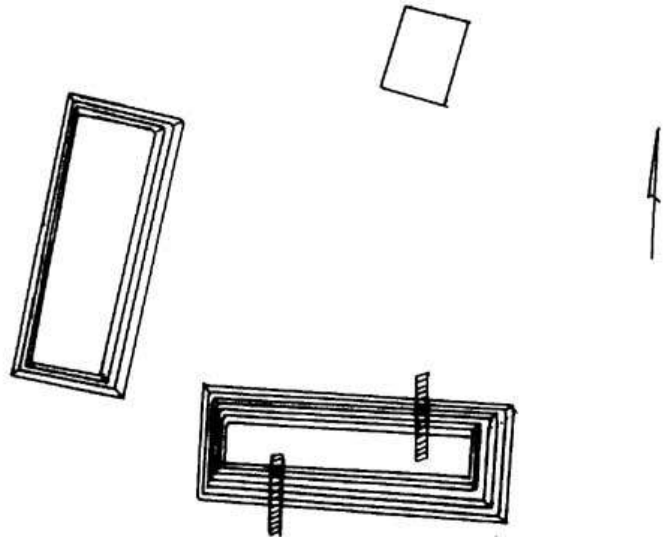

This group is located on the following coordinates: 16Q 0258647 and UTM 1894058, on the south sector of a truck road which branches off the road leading to Naranjo, on the intersection with a cattle ranch owned by the Burgos family. This compound is associated with a small elevation, and with a low, dense forest in which the following trees predominate: *cedrillo*, *zapotillo*, *ramón*, *mano de león*, *chacaj*, *luin*, *sunsa macho*, *chicozapote*, *yaxnic*, *escobo*, and *botán*.

This group consists of a single plaza defined by three structures of rectangular shape, which leave open the space on the east side. The mound on the north side is the one with less area and height, while the structures on the south and west appear to have been vaulted palaces. Two looter's tunnel-trenches were found related to the south building, one on the front façade and one on the back side.

<i>La Sequía Group</i>					
PATIO	STRUCTURE	LENGTH	WIDTH	HEIGHT	LOOTING
1	1	7.50	4.50	0.30	
	2	7.00	4.50	4.00	1 n, 1 s
	3	5.00	3.80	2.00	

El Cansancio Group
(Code 79)

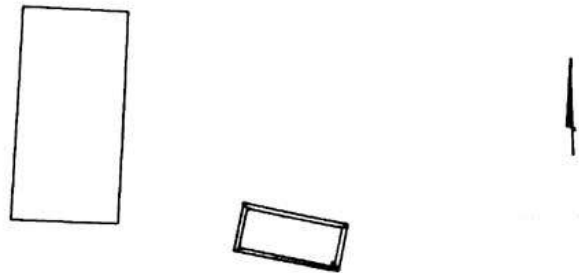

Naranjo, Petén
Periferia SW- Grupo 79
Zona Bajo La Pita Sur
Escala:1200

This group is located on the following coordinates: 16Q 0258610 and UTM 1894058, at an altitude of ? m asl. It is accessed by a truck road which branches off the road leading to Naranjo, near a cattle ranch belonging to the Burgos family. It is associated with a small elevation with flat terrain at the top, and with a

tall, dense forest, in which the following trees predominate: *zapotillo*, *ramón*, *mano de león*, *chacaj*, *luin*, *sunsa macho*, *chicozapote*, *yaxnic*, *escobo*, and *botán*.

This group consists of a plaza defined by two structures of rectangular shape, leaving the north and east sides open, which are characterized by having their axes deviated to the east. Functionally they seem to pertain to domestic units.

<i>El Cansancio Group</i>					
PATIO	STRUCTURE	LENGTH	WIDTH	HEIGHT	LOOTING
1	1	7.50	4.50	0.90	
	2	7.00	4.50	1.00	
	3	5.00	3.80	0.70	

Appendix 6

BAJO LA PITA REGION, WEST ZONE

Urraca Group
(Code 83)

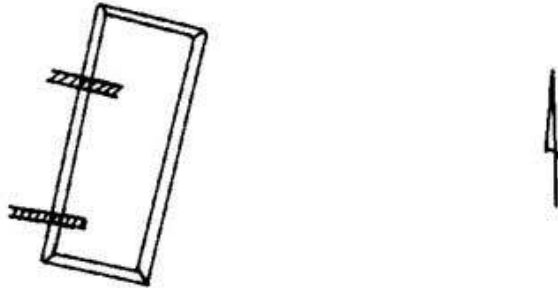

Naranjo, Petén
Periferia Oeste, Grupo 83
Zona Bajo La Pita Oeste
Escala 1;200

This group is located on the following coordinates: 16Q 0259516 and UTM 1894629, at an altitude of ? m asl. Access to the group is via a truck road which branches off the road leading to Naranjo, near a cattle ranch owned by the Burgos family. It is associated with a small elevation with flat terrain on the top, and with a tall, dense forest in which the following trees predominate: *cedrillo*, *zapotillo*, *ramón*, *mano de león*, *chacaj*, *luin*, *sunsa macho*, *chicozapote*, *yaxnic*, *escobo*, and *botán*.

This group consists of an isolated residential structure built with masonry and a roof of perishable material. Two looter's trenches were found on the façade on the west side.

Urraca Group					
PATIO	STRUCTURE	LENGTH	WIDTH	HEIGHT	LOOTING
1	1	5.20	5.20	1.00	2 W

Cabrillo Group
(Code 84)

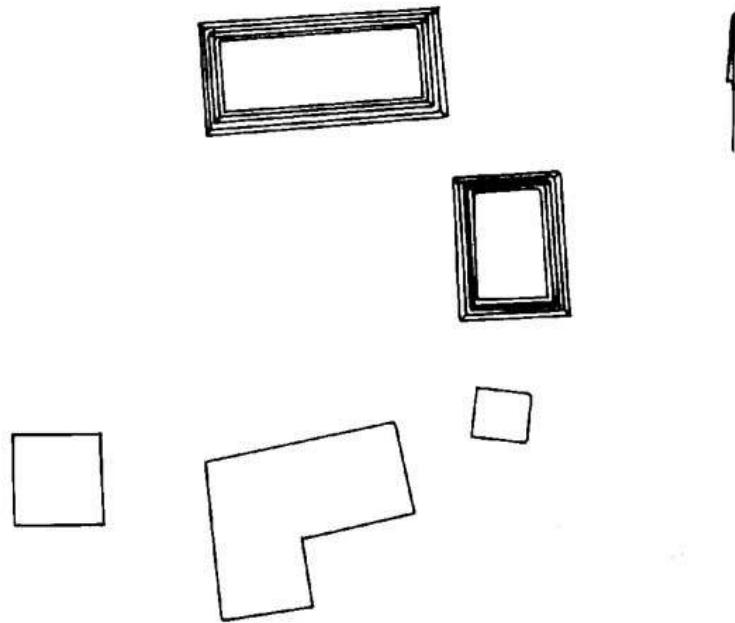

Naranjo, Petén
Periferia Oeste, Grupo 84
Zona Bajo La Pita Oeste
Escala 1;200

This group is found on the following coordinates: 16 Q0256561 and 1894676 UTM, at an altitude of 267 m asl. It is located on a slight natural elevation, and is associated with a forest with the following trees: *pije*, *chicozapote*, *guaya*, *cedrillo blanco*, *zapotillo*, *ramón*, and *botán* palms.

The group follows an irregular plaza arrangement which is open to the west, and is integrated by five structures organized in an asymmetrical fashion. The north side is occupied by a sanctuary of rectangular base, which could be a vaulted palace. It has a looting on the back side. In the plaza's east side there is a sanctuary of rectangular plan which was preyed upon by a pit and trench which

cut part of the façade, as well as a trench which cut part of the back side. Almost on the plaza's southeast corner, and almost attached to the temple, there is a low foundation of square plan which may have been an auxiliary unit at the service of the sanctuary. The plaza's south side is occupied by a structure with an L-format with the appendage oriented toward the south. In the west sector of the said structure there is a low foundation of square plan, which may also have served as service area or annex.

<i>Cabrito Group</i>					
PATIO	STRUCTURE	LENGTH	WIDTH	HEIGHT	LOOTING
1	1	6.00	4.40	2.50	1 N,
	2	8.80	6.40	2.50	1 west
	3	6.40	3.80	0.30	
	4	3.00	3.00	0.60	
	5	4.20	6.20	0.40	

Pizote Group
(Code 85)

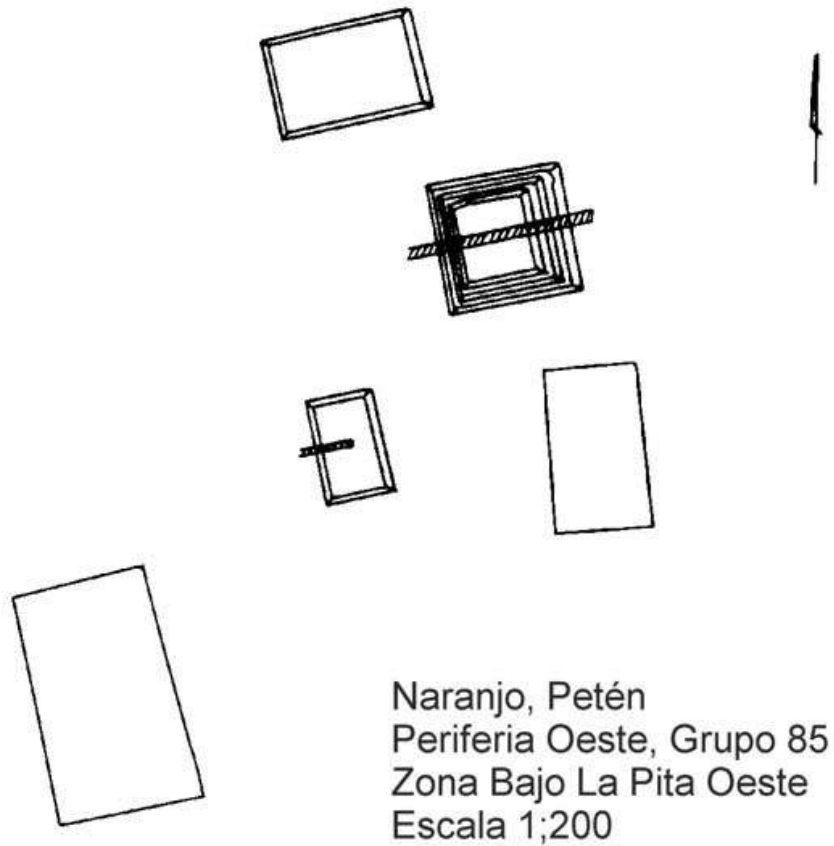

This group is located on the following coordinates: 16 Q0256546 and 1894774 UTM, beside the truck road leading to the northeast toward the El Pital *aguada* (water hole). The group occupies the high, broken part of a hill at an altitude of 272 m asl. It is associated with the following trees: *chacaj*, *cedro*, *pimienta*, *pij*, *chicozapote*, *matapalo*, *ramón*, and *jesmo*, there are *botán* palms as well.

This group follows an asymmetrical open plaza format on the west sector, which is integrated by five structures showing a notable deviation to the west. As seen in their arrangement, the buildings could in fact define three patios. The north sector is defined by a rectangular platform which apparently had a residential function. The east side is occupied by a temple of square base which was cut across on an east-west axis by a tunnel showing the remains of a probable earlier construction. On one side of the temple in the south sector there is a low platform which appears to have functioned as a service structure for the temple. The patio's south side is defined by a rectangular building with the long section along the north-south axis. This building confronts structure 3 described above, with which it seems to form a secondary plaza area. Somewhat distant from the group in the southwest sector is a rectangular structure which had the main

façade oriented toward the west, which could pertain to a masonry building with roof made of perishable material.

<i>Pizote Group</i>					
PATIO	STRUCTURE	LENGTH	WIDTH	HEIGHT	LOOTING
1	1	5.80	3.20	1 m	
	2	4.20	2.80	3 m	Tunnel E-W
	3	4.20	2.60	0.70 m	
	4	3.60	2.5.0	1 m	1 West
				1 m	

Enjambre Group
(Code 86)

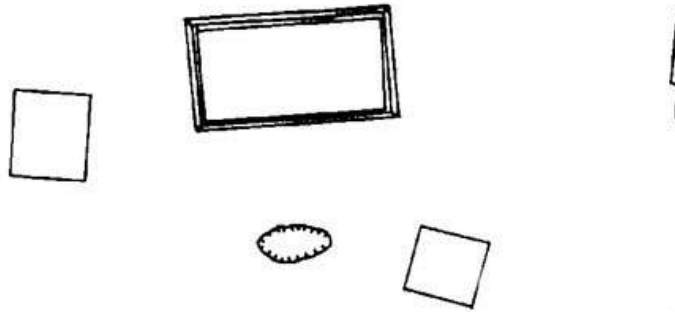

Naranjo, Petén
Periferia Oeste, Grupo 86
Zona Bajo La Pita Oeste
Escala 1;200

This group is located on the following coordinates: 16 Q0256762 and 1895040 UTM, beside the truck road that goes on a northwest direction toward the El Pital aguada. The group is on the high part of a hill at an altitude of 295 m asl. It is associated with the following trees: *jobillo*, *cilión*, *chicozapote*, *cedrillo*, *chaltecoco*, *cuero de zapo*, *copal*, *ramón*, and *chacaj*, as well as *guano* palms.

This group follows an plaza format open to the south sector, it is integrated by three structures showing a deviation toward the east and west, which seem to

pertain to domestic units. The north sector is defined by a rectangular structure that includes a looter's trench on the north side. The east side is occupied by a low sanctuary of square base, which confronts another similar structure. In the middle of the plaza there is a quarry of approximately 3 x 1.50 m.

<i>Enjambre Group</i>					
PATIO	STRUCTURE	LENGTH	WIDTH	HEIGHT	LOOTING
1	1	8.80	5.00	1.50	1 N
	2	3.00	3.00	0.30	
	3	4.00	4.40	0.40	

Pajarito Group
(Code 87)

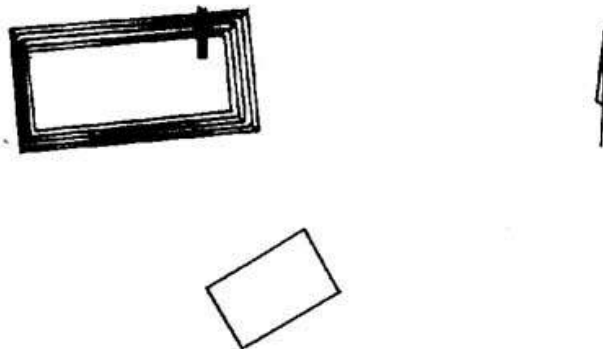

Naranjo, Petén
Periferia Oeste, Grupo 87
Zona Bajo La Pita Oeste
Escala 1;200

This group is located on the following coordinates: 16 Q0256604 and 1894961 UTM, beside the truck road leading to the northwest toward the aguada El Pital. The group is on a sort of plateau at an altitude of 279 m asl, with a transitional vegetation consisting of *zapotillo*, *quina*, *chacaj*, *cedro*, *caoba* (*mahogany*), *yaxnic*, *pij*, *lui*, *jobo*, *ramón*, and *jesmo*, there also are *botán* and *escobo* palms. On the south side of the plaza the terrains tends to rise.

This group follows an open plaza format in the east and west sectors. It is integrated by two structures showing a double deviation toward the west. The north sector is defined by a low palace residential structure of rectangular plan, which includes a looter's trench on the north façade. The plaza's south side is defined by a low structure of smaller dimensions.

<i>Pajarito Group</i>					
PATIO	STRUCTURE	LENGTH	WIDTH	HEIGHT	LOOTING
1	1	9.80	5.00	2.50	1 N
	2	4.60	4.00	0.80	

Pimienta Group
(Code 88)

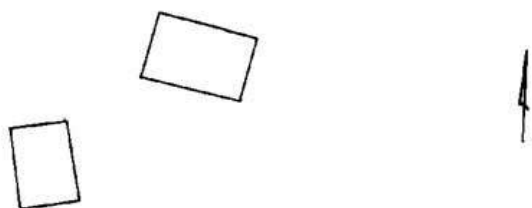

Naranjo, Petén
Periferia Oeste, Grupo 88
Zona Bajo La Pita Oeste
Escala 1;200

This group is located on the following coordinates: 16 Q0256634 and 1894891 UTM, besides the truck road leading to the northwest toward the El Pital aguada. The group is on the high and broken part of a hill, at an altitude of 270 m asl. It is associated with the following trees: *puntero*, *chacaj*, *chintoc*, *cedrillo*, *pimienta*, *pij*, *jesmo*, *ramón*, *copa*, *l* and *malerio*, as well as *guano* and *escobo* palms.

This group follows an open plaza format on the east and south sectors, integrated by two structures showing a double deviation to the west and east. The north sector is defined by a low foundation of rectangular plan. The plaza's west side is defined by another rectangular structure, both structures seem to be domestic units. No lootings are seen here.

<i>Pimienta Group</i>					
PATIO	STRUCTURE	LENGTH	WIDTH	HEIGHT	LOOTING
1	1	4.80	3.20	0.40	
	2	4.00	3.00	0.30	

La Blusa Group
(Code 89)

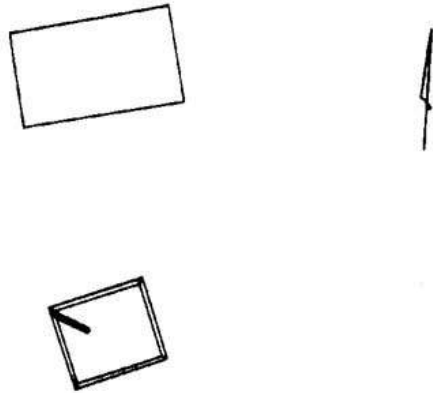

Naranjo, Petén
 Periferia Oeste, Grupo 89
 Zona Bajo La Pita Oeste
 Escala 1:200

This group is located on the following coordinates: 16 Q0256659 and 189934 UTM, beside the truck road leading to the northwest toward the El Pital aguada. The group is on the high, broken part of a hill at an altitude of 295 m asl. It is associated with the following trees: *chacaj*, *cedro*, *pimienta*, *pij*, *chicozapote*, *matapalo*, *ramón*, and *jesmo*, as well as *botán* palms.

This group follows an open plaza format on the east and west sectors. It is integrated by two structures showing a notable deviation toward the west. The north sector is defined by a low foundation of rectangular plan. The plaza's south side is defined by a square structure, perhaps a sanctuary, which was affected by a looter's trench (8 m) cutting across it on the northwest corner sector.

<i>La Blusa Group</i>					
PATIO	STRUCTURE	LENGTH	WIDTH	HEIGHT	LOOTING
1	1	8.00	5.00	0.80	
	2	4.80	4.80	1.00	1 NW

Bejuco de Agua Group
(Code 90)

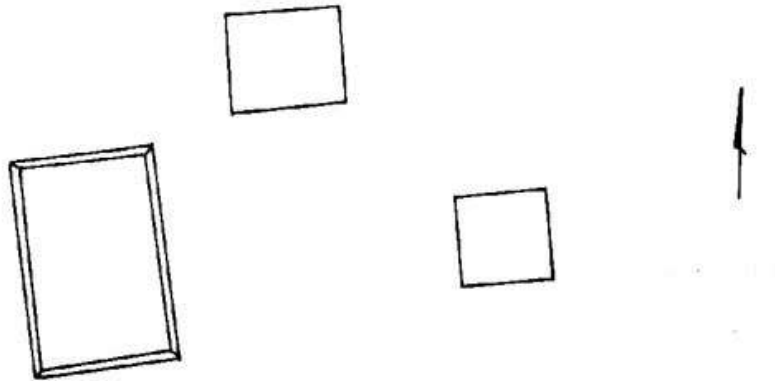

Naranjo, Petén
Periferia Oeste, Grupo 90
Zona Bajo La Pita Oeste
Escala 1;200

This group is located on the following coordinates: 16 Q0256900 and 1895204 UTM, besides the truck road leading on a northwest direction toward the El Pital aguada. The group is on a hill at an altitude of 271 m asl. It is associated with the following trees: *pimienta*, *zapotillo*, *guaya*, *cedrillo*, *chaltecoco*, *cuero de sapo*, *copal*, *ramón*, and *chacaj*, as well as *guano* palms.

This group follows an open plaza format on the south sector, and is integrated by three structures showing a deviation toward the west, which seem to pertain to domestic units. The north sector is defined by a rectangular structure. The east side is occupied by a low sanctuary of square base, which confronts a structure that could have had masonry walls. No signs of looting were found here.

<i>Bejuco de Agua</i>					
PATIO	STRUCTURE	LENGTH	WIDTH	HEIGHT	LOOTING
1	1	4.80	4.00	0.50	
	2	3.80	3.80	0.50	
	3	8.80	6.00	1.10	

Gavilán Group
(Code 91)

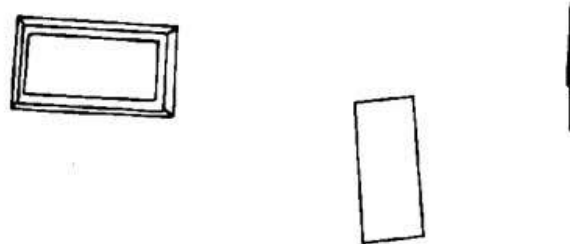

Naranjo, Petén
 Periferia Oeste, Grupo 91
 Zona Bajo La Pita Oeste
 Escala 1;200

This group is located on the following coordinates: 16 Q0256889 and 1895272 UTM, beside the truck road that goes on a northwest direction toward the El Pital aguada. This group occupies the high and broken part of a hill, at an altitude of 314 m asl. It is associated with the following trees: *puntero*, *laurel*, *mano de león*, *chacaj*, *valerio*, *yaya*, *pij*, *jesmo*, *ramón*, and *copal*.

This group follows an open plaza format in the south and west sectors. It is integrated by two structures showing a remarkable deviation to the west and east, which seem to be residential units. The north sector is defined by a rectangular foundation showing a looting on the south façade. The east side of the plaza is defined by another rectangular structure. The looting allows one to see the walls of several precincts of structure 1. Regrettably no sherds were found associated with this structure.

<i>Gavilán Group</i>					
PATIO	STRUCTURE	LENGTH	WIDTH	HEIGHT	LOOTING
1	1	7.00	4.00	1.50	1 S
	2	6.20	3.00	0.60	